

**APPENDIX C**  
**Geotechnical Investigation Report**





Geotechnical  
 Environmental  
 Hydrogeology  
 Material Testing  
 Construction Inspection

February 18, 2021

Project No. 20-7176

Xebec Building Company  
 3010 Old Ranch Parkway, Suite 480  
 Seal Beach, CA 90740

Attention: Sylvia Tran, Senior Development Manager & Business Development

Subject: Geotechnical Investigation Report, Figueroa Street Business Park, SEC of  
 Figueroa Street and LA County Flood Control Channel, Carson, California

Sylvia,

In accordance with your request and authorization, TGR Geotechnical, Inc. (TGR) has performed a geotechnical investigation for the proposed development at the subject site in the City of Carson, California. The site is underlain by the Gardena Valley 1 and 2 Class II Landfill and the site is covered by a surficial layer of fill which is underlain by landfill deposits which extend to depths of approximately 35 feet below existing grades. It is our understanding that the proposed development consists of two industrial buildings (Building 1 – 180,200 sq. ft and Building 2 – 116,300 sq. ft.) with associated truck docks on the north side of the buildings and vehicle parking on the north, south and west sides of the site. A potential future 4,000 sq. ft. drive-through development with associated parking is proposed on the far west side of the site. This report presents the findings of our geotechnical investigation, including site seismicity, seismic settlement, liquefaction potential and provides geotechnical design recommendations for the proposed improvements. The work was performed in general accordance with our proposal dated January 8, 2021.

Based on our investigation the proposed development is feasible from a geotechnical viewpoint provided the recommendations presented in this report are implemented during design and construction.

If you have any questions regarding this report, please do not hesitate to contact this office. We appreciate this opportunity to be of service.

Respectfully submitted,

**TGR GEOTECHNICAL, INC.**

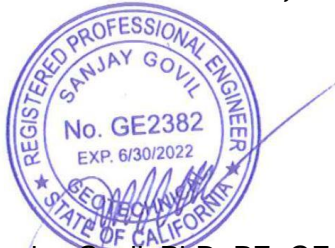

Sanjay Govil, PhD, PE, GE 2382  
 Principal Geotechnical Engineer



Edward L. Burrows, M.S, PG, CEG 1750  
 Principal Engineering Geologist

Distribution: (4) Addressee

TGR GEOTECHNICAL  
 DBE & 8(a) firm  
 3037 S. HARBOR BLVD  
 SANTA ANA, CA 92704  
 P 714.641.7189 F 714.641.7190  
 www.tgrgeotech.com

**Attachments:**

Plate 1 – Boring Location Map

Figure 1 – Site Location Map

Figure 2 – Regional Geology Map

Figure 3 – Historic High Groundwater Map

Figure 4 – Regional Fault Map

Figure 5 – Seismic Hazard Zone Map

Figure 6 – Pile Capacity

Appendix A – References

Appendix B – Log of Borings (TGR and Coleman Geotechnical)

Appendix C – Laboratory Testing Procedures and Results (TGR and Coleman Geotechnical)

Appendix D – Site Seismic Design and De-Aggregated Parameters

Appendix E – Standard Grading Specifications

## **EXECUTIVE SUMMARY**

Presented below are significant elements of our findings from a geotechnical viewpoint. These findings are based on our field exploration, laboratory testing, and geologic and engineering analysis.

### **Geotechnical/Geologic Concerns**

- There are no known faults passing through or adjacent to the subject site. The subject site is not located within an Alquist-Priolo Earthquake Fault Zone. The nearest fault to the subject site is the Newport-Inglewood-Rose Canyon Fault mapped approximately 2.7 miles to the east, of the site. Other faults nearby include Palos Verdes Fault mapped 4.7 miles southwest of the subject site and the Charnock Fault mapped 7.7 miles northwest of the subject site.
- The subject area has approximately 5 feet of soil fill underlain by landfill deposits up to the depth of approximately 35 below existing grade. The landfill deposits consist of greenish gray mixed trash, mostly of wood, paper, soil, plastic, metal etc.
- Seepage water was encountered during the exploration at depth ranging from 40 to 50 feet below existing ground surface. Static groundwater was not encountered during drilling.
- The potential for liquefaction, seismic settlement and differential seismic settlement is considered very low to negligible based on the depth to groundwater and the clayey nature of the alluvial soils below the landfill.

### **Foundations**

- The proposed industrial buildings and potential future drive-through development shall be supported on driven pile foundations. The driven piles shall be a minimum of 16-inch square and a minimum of 60 feet deep below existing ground surface.
- The allowable axial capacity of 16-inch square pile (fixed head) is presented in Figure 6.
- Laboratory test results indicate that concrete in contact with onsite native soils should be designed for exposure class S2 (minimum 4,500 psi concrete) and exposure class C1.

### **Slab-on-Grade**

- Building slab may be designed as a structural slab supported on driven piles and grade beams. The thickness and reinforcement of the slab shall be designed by the structural engineer per the 2019 California Building Code and should include the anticipated loading condition (fork lift etc.), the anticipated use of the building.
- Areas requiring moisture sensitive flooring shall be underlain by a minimum 15-mil visqueen (Stego Wrap or equivalent).

Pavement Design

ASPHALT PAVEMENT SECTION					PCC PAVEMENT SECTION		
Pavement Utilization	Traffic Index	Asphalt (Inch)	Aggregate Base (Inch)	Total (Inch)	*PCC	Aggregate Base (Inch)	Total (Inch)
Parking Stalls	4.5	3.5	7.0	10.5	--	--	--
Auto Driveways	5.0	4.0	8.0	12.0	--	--	--
Truck Aisles/ Driveways	6.0	5.0	10.0	15.0	7.5	6.0	13.5
Loading Dock	7.0	6.0	12.0	18.0	8.0	6.0	14.0

\*Minimum concrete compressive strength of 3,000 psi.

\*\* Shall also comply with City requirements

## INTRODUCTION

### Site Descriptions and Proposed Project Development

The subject site is located at west side of Figueroa Street, approximately 450 feet north of Torrance Boulevard, (Figure 1) in the City of Carson, California. The site is underlain by the Gardena Valley 1 and 2 Class II Landfill and the site is covered by a surficial layer of fill which is underlain by landfill deposits which extend to depths of approximately 35 feet below existing grades. We understand that the proposed development will consist of two industrial buildings (Building 1 – 180,200 sq. ft and Building 2 – 116,300 sq. ft.) with associated truck docks on the north side of the buildings and vehicle parking on the north, south and west sides of the site and a potential future 4,000 sq. ft. drive-through development with associated parking is proposed on the far west side of the site. It is our understanding that a multi-layer landfill cap is required for the project which will consists of 24 inch foundation soil layer, overlain by a composite barrier layer, overlain by a composite drainage layer, overlain by an 18-inch crushed stone subbase, and a 4-in bituminous pavement (Haley & Aldrich, 2005).

### Scope of Work

The scope of work for this geotechnical investigation included the following:

- Site reconnaissance to assess current site conditions and mark borings.
- Sampling and logging five (5) hollow stem auger borings utilizing a hollow stem drill rig to a depth of 76.5 feet at the subject site to evaluate subsurface soil conditions. The borings were backfilled with bentonite grout. The cuttings from the borings were drummed and left onsite for testing and disposal.
- Laboratory testing of selected samples of the native material below the landfill to include in-situ moisture density, shear, sulfates, passing No. 200 sieve, Atterberg limits.
- Engineering analysis including site seismicity, foundation design, liquefaction analysis and settlement.
- Preparation of this report summarizing subsurface soil conditions, site seismicity, results of liquefaction analysis, seismic settlement and provide pertinent geotechnical/geologic information that may influence the proposed development.

### Previous Studies

Prior to the preparation of this report, TGR was provided with the following Reports for the subject site or adjacent sites. Findings and conclusions from these reports are as follows:

Draft Remedial Investigation Report, Groundwater Operable Unit for a Portion of the Gardena Valley 1 & 2 Landfill, Los Angeles County's Assessor's No. 7336-3-30, prepared by Bryan A. Stirrat & Associates, Inc., dated May 1993. The purpose of this investigation was to characterize the geology, hydrogeology, and chemistry of the subsurface at the Gardena Valley 1 & 2 Landfill. According to this investigation the general site area rests on sediment of the Late Pleistocene Upper Lakewood Formation with areas of recent flood plain deposits. The upper portion of the Lakewood Formation is comprised of mainly fine-grained materials such as silts, silts sands, and

clays with discontinuous sandy zones. These deposits represent typical meandering alluvial stream deposits with fine grained flood plain deposits. The Lakewood Formation extends approximately 220 below ground surface. Underlying the Lakewood Formation unconformably is the lower Pleistocene San Pedro Formation. This unit consists of stratified unconsolidated sand with some interbeds of fine gravel, silty sand, and silt and is thought to be primarily of marine origin. This formation is estimated to extend to a depth of approximately 1,050 feet near the Gardena Valley 1 & 2 Landfill site. The general site area is underlain by a semi-perched aquifer which has been designated as the Bellflower Aquiclude. This aquifer receives most of its recharge via rainfall infiltration. The Gage Aquifer underlies the Bellflower Aquiclude at depth of approximately 65 feet below mean sea level.

Geotechnical Investigation, Carson Valley Mixed Use Project, East Side of Figueroa St. About 350 Feet North of Torrance Blvd., Carson, CA, prepared by Coleman Geotechnical, dated May 14, 2004, Job No. 2336. The purpose of this investigation was to obtain information on the general regional geologic conditions and specific subsurface conditions within the project area with respect to the proposed development. This proposed project was located within the existing Gardena Valley Landfill 1 and 2 property. As part of this study five test borings were drilled to depths of 50 to 55 feet below existing grades. The subsurface conditions generally consisted of a surficial layer of fill soil about 6 to 7 feet thick which was underlain by landfill deposits. The landfill deposits extended to depths of about 34 to 35 feet below existing grades at the boring locations. The landfill deposits were classified as mixed trash, soil and concrete rubble, with much of the trash being wood and paper, with lesser metal and plastic. Below the landfill deposits, natural alluvial soils consisting of predominantly of silt and clay were encountered throughout the remaining explored depth of 50 to 55 feet below existing grade. The alluvium was classified as being generally firm to stiff. Seepage of water was encountered in four of the borings at depths of about 40 to 45 feet below grade. The boring logs and associated laboratory test data are included in Appendix B and C, respectively.

Geotechnical Feasibility Evaluation, Gardena Valley Landfill 1 & 2 Property, Carson City, California, prepared by Haley & Aldrich, dated 12 July 2005, File No. 32143-001. The purpose of this study was to research available geotechnical information, conduct a limited subsurface investigation to view the nature of the waste materials in the landfill and make preliminary evaluations of geotechnical aspects of site building design and construction. Seventeen test pits were performed with a track hoe excavator to depths of approximately 20 to 21 feet. The materials encountered in the test pits consisted primarily of fill soil and landfill waste. The waste consisted of wood construction debris, concrete rubble, paper and cardboard, metal cans and scraps, vegetation, rubber tires, household trash and decomposed waste having the consistency of organic topsoil. Historical test borings by others indicate waste debris down to approximately 34 to 35 feet below ground surface (bgs). The configuration of the waste profile was observed to be consistent around the site perimeter. Test pits did not encounter areas where solid waste was detectably thinner nor were sloped interfaces encountered between the bottom of waste and natural deposited soils in pits near Figueroa and Main Streets indicating that the extent of waste must either end very abruptly near the street line, or extend under the edge of the street. Previous subsurface activities conducted by others indicate that the site is underlain by the Lakewood Formation which extend to greater than approximately 180 feet bgs. Borings indicate alternating layers of silt, clay clayey sand, silty sand and sand to approximately 90 feet bgs, which is underlain by approximately 50 feet of relatively clean, poorly graded fine sand to approximately



140 feet bgs. The soils underlying the solid waste were classified as Alluvium, consisting of clayey silt and silt, with varying amounts of fine sand. Soil classification data for the soils underlying the waste indicate that the soil is classified as clay of low plasticity (CL), with a Liquid Limit between 34 and 42, and a Plasticity Index between 15 and 20. Significant settlement of the pavement was observed on adjacent properties to the south of the subject site, indicating visual evidence of the reported solid waste. In the parking areas beyond the southeastern edge of the subject site differential settlement of approximately 1 to 3 feet was observed. At the limits of the settlement, severe distress and cracking of the pavement was visible. Multi-layer landfill cap is required for the project which will consist of 24 inch foundation soil layer, overlain by a composite barrier layer, overlain by a composite drainage layer, overlain by an 18-inch crushed stone subbase, and a 4-in bituminous pavement.

### Field Investigation

Field exploration was performed on January 21, 22, 26, 27 and February 2, 2021 by representatives from our firm who logged the borings and obtained representative samples, which were subsequently transported to the laboratory for further review and testing. The approximate locations of the borings are indicated on the enclosed Boring Location Map (Plate 1).

The subsurface conditions were explored by drilling, sampling, and logging five (5) borings with a truck mounted hollow stem drill rig. Borings B-1 through B-5 were advanced to an approximate depth of seventy six and half (76.5) feet below existing grade. Subsequent to drilling, all borings were backfilled with bentonite. The log of borings presenting soil conditions and descriptions are presented in Appendix B.

The drill rig was equipped with a sampling apparatus to allow for recovery of driven modified California Ring Sampler (CRS), 3-inch outside diameter, and 2.42-inch inside diameter and SPT samples.

The samples were driven using an automatic 140-pound hammer falling freely from a height of 30 inches. The blow counts for CRS were converted to equivalent SPT blow counts. Soil descriptions were entered on the logs in general accordance with the Unified Soil Classification System (USCS). Driven samples and bulk samples of the earth materials encountered at selected intervals were recovered from the borings. The locations and depths of the soil samples recovered are indicated on the boring logs in Appendix B.

### Laboratory Testing

Laboratory tests were performed on representative samples to verify the field classification of the recovered samples and to evaluate the geotechnical properties of the subsurface soils. The following tests were performed:

- In-situ moisture content (ASTM D2216) and dry density (ASTM D7263);
- Direct Shear Strength (ASTM D3080);
- Passing No. 200 sieve (ASTM 1140);
- Atterberg Limits (D4318); and
- Soluble Sulfate (CAL.417A)

Laboratory tests for geotechnical characteristics were performed in general accordance with the ASTM procedures. The results of the in-situ moisture content and density tests are shown on the borings logs. The results of the laboratory tests are presented in Appendix C.

## **GEOTECHNICAL FINDINGS**

### Geology

#### Regional Geologic Setting

The project site is located in the northeast portion of the Torrance 7.5-minute Quadrangle, Los Angeles County, California. Per the Geologic Map of the Palos Verdes Peninsula and Vicinity, Redondo Beach, Torrance and San Pedro Quadrangles, California (Dibblee, 1999), the subject site is underlain by Quaternary alluvial deposits. Figure 2 presents the Regional Geology Map.

#### Earth Units

Based on our subsurface investigation, the subject area has approximately 5 feet of loose soil fill underlain by landfill deposits up to the depth of approximately 35 below existing grade. The landfill deposits consist of greenish gray mixed trash, mostly of wood, paper, soil, plastic, metal etc. Native soil encountered below a depth of 35 feet to the maximum depth explored (approximately 76.5 feet). Native soil consists of grayish brown to olive brown, medium stiff to stiff sandy clay and clay in moist to very moist condition underlain by clayey sand and sand. Seepage of water was encountered at depths of about 40 to 45 feet below the existing grade. Detailed descriptions of the earth units encountered in our borings are presented in the log of the borings. (Appendix B)

#### Groundwater

Seepage water was encountered during the exploration at approximately 40 to 50 feet below existing ground surface. No static groundwater was encountered during this and the previous investigation by Coleman Geotechnical. It is our understanding that regional groundwater (Gage Aquifer) is located at approximately 95 feet below existing grade (BAS, 1993). A review of the seismic hazard zone report for the Torrance quadrangle indicates that historically high groundwater is not mapped in the project vicinity (Figure 3). Seasonal and long-term fluctuations in the groundwater may occur as a result of variations in subsurface conditions, rainfall, run-off conditions and other factors. Therefore, variations from our observations may occur. Static groundwater is not anticipated to impact the proposed development.

#### Seismic Review

##### Faulting and Seismicity

The subject site, like the rest of Southern California, is located within a seismically active region as a result of being located near the active margin between the North American and Pacific tectonic plates. The principal source of seismic activity is movement along the northwest-trending regional faults such as the San Andreas, San Jacinto and Elsinore fault zones. These fault systems produce approximately 5 to 35 millimeters per year of slip between the plates.

By definition of the State Mining and Geology Board, an active fault is one which has had surface displacement within the Holocene Epoch (roughly the last 11,000 years). The State Mining and Geology Board has defined a potentially active fault as any fault which has been active during the Quaternary Period (approximately the last 1,600,000 years). These definitions

are used in delineating Earthquake Fault Zones as mandated by the Alquist-Priolo Geologic Hazard Zones Act of 1972 and as subsequently revised in 1994 (Hart, 1997) as the Alquist-Priolo Geologic Hazard Zoning Act and Earthquake Fault Zones.

The intent of the act is to require fault investigations on sites located within Special Studies Zones to preclude new construction of certain inhabited structures across the trace of active faults.

The subject site is not included within any Earthquake Fault Zones as created by the Alquist-Priolo Earthquake Fault Zoning Act (Hart, 1997). Our review of geologic literature pertaining to the site area indicates that there are no known active or potentially active faults located within or immediately adjacent to the subject property.

The nearest fault to the subject site is the Newport-Inglewood-Rose Canyon Fault mapped approximately 2.70 miles to the east, of the site. Other faults nearby include Palos Verdes Fault mapped 4.70 miles southwest of the subject site and the Charnock Fault mapped 7.70 miles northwest of the subject site. The regional fault map, Figure 4, shows the location of the subject site in respect to the regional faults.

### Secondary Seismic Hazards

#### Surface Fault Rupture and Ground Shaking

Since no known faults are located within the site, surface fault rupture is not anticipated. However, due to the close proximity of known active and potentially active faults, severe ground shaking should be expected during the life of the proposed structures.

#### Liquefaction

Liquefaction is a seismic phenomenon in which loose, saturated, fine-grained granular soils behave similarly to a fluid when subjected to high-intensity ground shaking. Liquefaction occurs when these ground conditions exist: 1) Shallow groundwater; 2) Low density, fine, clean sandy soils; and 3) High-intensity ground motion. Effects of liquefaction can include sand boils, settlement, and bearing capacity failures below foundations.

Based on our review of Seismic Hazard Zones in California, the subject site is partially located within a mapped liquefaction zone (Figure 5).

The potential for liquefaction, seismic settlement and differential seismic settlement is considered negligible based on the depth to static groundwater (Gage Aquifer) of approximately 95 feet, the clayey nature of the alluvial soils below the landfill.

#### Seismically Induced Settlement

Ground accelerations generated from a seismic event can produce settlements in sands or in granular earth materials both above and below the groundwater table. This phenomenon is often referred to as seismic settlement and is most common in relatively clean sands, although it

can also occur in other soil materials. The potential for seismically induced settlement within the native soils underlying the landfill at the subject site is low.

### Lateral Spreading

Seismically induced lateral spreading involves primarily movement of earth materials due to earth shaking. Lateral spreading is demonstrated by near-vertical cracks with predominantly horizontal movement of the soil mass involved. The depth to native soils is approximately 35 feet. Therefore, the potential for lateral spreading at the subject site is considered low.

## **DISCUSSIONS AND CONCLUSIONS**

### **General**

Based on our field exploration, laboratory testing and engineering analysis, it is our opinion that the proposed structures and proposed grading will be safe against hazard from landslide, settlement, or slippage and the proposed construction will have no adverse effect on the geologic stability of the adjacent properties provided our recommendations presented in this report are followed.

### **Conclusions**

Based on our findings and analyses, the subject site is likely to be subjected to moderate to severe ground shaking due to the proximity of known active and potentially active faults. This may reasonably be expected during the life of the structure and should be designed accordingly.

The primary conditions affecting the proposed project site development are as follows:

- Presence of landfill material to a depth of approximately 35 feet.
- Site settlement

The engineering evaluation performed concerning site preparation and the recommendations presented are based on information provided to us and obtained by us during our office and fieldwork. This report is prepared for the development of two industrial buildings with associated truck docks and parking and a potential future drive-through development at the subject property. In the event that any significant changes are made to the proposed development, the conclusions and recommendations contained in this report shall not be considered valid unless the changes are reviewed, and the recommendations of this report are verified or modified in writing by TGR.

## RECOMMENDATIONS

### Seismic Design Parameters

When reviewing the 2019 California Building Code the following data should be incorporated into the design.

Parameter	Value
Latitude (degree)	33.843864
Longitude (degree)	-118.28229
Site Class	D
Site Coefficient, $F_a$	1.0
Site Coefficient, $F_v$	null
Mapped Spectral Acceleration at 0.2-sec Period, $S_s$	1.726 g
Mapped Spectral Acceleration at 1.0-sec Period, $S_1$	0.62 g
Spectral Acceleration at 0.2-sec Period Adjusted for Site Class, $S_{MS}$	1.726 g
Spectral Acceleration at 1.0-sec Period Adjusted for Site Class, $S_{M1}$	null
Design Spectral Acceleration at 0.2-sec Period, $S_{DS}$	1.151 g
Design Spectral Acceleration at 1.0-sec Period, $S_{D1}$	null

### Site Specific Response Spectra

The USGS Unified Hazard tool, the USGS RTGM Calculator and the USGS App for Deterministic Spectra Acceleration were utilized to develop site specific ground motion spectra. The analysis was performed utilizing the following attenuation relationships that are part of NGA as required by 2019 CBC code requirements.

- Campbell & Bozorgnia (2014)
- Boore, Stewart, Seyhan & Atkinson (2014)
- Chiou & Youngs (2014)
- Abrahamson, Silva & Kamal (2014)

The results of the Site Specific Response Spectra are incorporated in Table 1 and on Figure 1 in Appendix D. The results include deterministic spectra at 5% damping, maximum rotated component at 0.84 fractile and the probabilistic spectra, maximum rotated component at 5% damping for a return period of 2475 year and subsequently multiplied by risk coefficient to obtain the MCER probabilistic spectral acceleration. The  $V_{s30}$  utilized was 260 m/s.

The above generated spectral accelerations were compared against the minimum code requirements in ASCE7-16 (Chapters 11 and 21) resulting in the final design response spectra which is presented in Table 1 and on Figure 1 in Appendix D.

Based on Table 1 and Figure 1, the recommended Site Specific  $S_{DS}$  and  $S_{D1}$  are as follows:

$$S_{DS} = 1.104$$
$$S_{D1} = 0.999$$

The structural consultant should review the above parameters and the 2019 California Building Code to evaluate the seismic design.

Mapped values may be used in lieu of site-specific values to design structures on Site Class D sites with an  $S_1$  greater than or equal to 0.2, provided the value of the seismic response coefficient  $C_s$  is determined by Eq. (12.8-2) for values of  $T \leq 1.5T_s$  and taken as equal to 1.5 times the value computed in accordance with either Eq. (12.8-3) for  $TL \geq T > 1.5T_s$  or Eq. (12.8-4) for  $T > TL$ .

Conformance to the criteria presented in the above table for seismic design does not constitute any type of guarantee or assurance that significant structural damage or ground failure will not occur during a large earthquake event. The intent of the code is "life safety" and not to completely prevent damage of the structure, since such design may be economically prohibitive.

#### Foundation Design Recommendations

The proposed industrial buildings and potential future drive-through development shall be supported on driven pile foundations. Foundation design recommendations are presented below.

#### Driven Pile Design Recommendations

Driven pile foundations can be used to support the structures and floor slabs. The concrete driven piles shall be founded in the underlying natural alluvial soils below the landfill and be a minimum of 60 feet deep below existing ground surface. The axial allowable downward pile capacity for 16-inch square concrete driven piles is presented in Figure 6. The above allowable capacity includes a 1.5 factor of safety.

The pile capacity assumes that the 4 to 5 feet of fill cap above the landfill will remain in place. Eliminating the fill cap will significantly reduce that lateral capacity. We have also assumed that the piles will have a fixed head (rigid pile cap).

Piles shall be spaced a minimum of three (3) diameters on center. The capacities are presented as a function of penetration below the pile caps. Capacities may be increased by one-third (1/3) for short-term wind and seismic loads. All piles shall be connected by grade beam to limit lateral movement and provide fixed head condition at the pile cap. For piles spaced at less than three (3) diameters on center, additional group capacity reduction effects should be taken into account in evaluating the allowable axial capacity of the pile groups.

The above allowable capacity is based on a combination of both end bearing and skin friction, and assume the piles will be founded in native stiff soils. The skin friction from top of the pile to the bottom of the landfill was neglected. Due to the presence of landfill material some down drag is anticipated. The upper 35 feet of the piles shall be coated to reduce the



down drag resulting from settlement of the landfill material. It is recommended that a down drag of 50kips/pile be utilized in the pile design. The piles within the landfill shall be designed to include the adverse impact of landfill leachate.

The pile spacing shall be at least 3 times the maximum dimension of the pile, center-to-center. Thus, reduction in axial capacity from group effects is not considered necessary.

The total settlement of piles designed in accordance with the above recommendations is anticipated to be less than 1-inch. Differential settlement between adjacent columns is anticipated to be less than 1/3-inch.

Due to the presence of landfill some difficulty could be encountered during pile driving, which may require pre-drilling. An indicator pile program shall be established prior to production pile to verify the design capacities and adjust pile length accordingly. Installation of drilled pier foundation will require disposal of landfill cutting and may require temporary casing to prevent caving.

The preliminary lateral capacity of the piles may be taken as approximately 10 percent of the axial capacities for the fixed head condition. The point of fixity should be taken as 5 feet below the bottom of the landfill.

TGR recommends that a minimum of 15 indicator piles be driven prior to placement of production piles. The location of these piles shall be provided by TGR. Depending upon the test results, the recommendations presented above shall be reviewed and revised, as necessary. The purpose of the indicator piles is to verify the required pile lengths and to evaluate the efficiency of the pile driving system. Dynamic pile driving measurements should be performed utilizing a pile driving analyzer (PDA). CAPWAP analysis should also be performed to verify design capacities. The indicator piles should be 10 feet longer than the design length.

The installation of piles should be performed under the full-time observation of TGR. A pile hammer system should be selected by the foundation contractor that will preclude overstressing the pile during driving. Driving cushions and followers should be capable of imparting a uniform distribution of hammer energy to the piles.

The allowable capacity of the driven piles should be verified during installation using a wave equation analysis or equivalent formula. If a specified pile length is reached without satisfying the capacity formula, pile driving should continue until the final set of pile equals or exceeds the required capacity. Piles which encounter practical driving refusal prior to reaching the specified length may be acceptable depending on pile and hammer behavior during driving. The geotechnical engineer should observe pile driving and evaluate each pile on a case by case basis. Continuous records of the pile driving operation should be kept and any field changes shall be reviewed by the project structural engineer.

### Cement Type and Corrosion

Based on laboratory testing concrete used should be designed in accordance with the provisions of ACI 318-14, Chapter 19 for Exposure Class S2 with a minimum unconfined compressive strength of 2,500 psi and for Exposure Class C1 (Moderate) – Concrete exposed to moisture but not to a significant external source of chlorides per ACI 318-14 Table 19.3.1.1.

Corrosion tests (Coleman, 2004) indicate a severely corrosive potential for ferrous metals exposed to site soils.

### Slab Design

The building slab may be designed as a structural slab supported on driven piles and grade beams.

The thickness and reinforcement of the slab shall be designed by the structural engineer per the 2019 California Building Code and should include the anticipated loading condition (fork lift etc.), the anticipated use of the building. For moisture sensitive flooring, the floor slab should be underlain by minimum 15-mil impermeable polyethylene membrane (Stego Wrap, Moistop Plus, or any equivalent meeting the requirements of ASTM E1745, Class A rating) as a capillary break. Sand may be placed above and below the impermeable polyethylene membrane at the discretion of the project structural engineer/concrete contractor for proper curing and finish of the concrete slab-on-grade and protection of the membrane and is considered outside the scope of geotechnical engineering.

### Site Settlement

#### General

The main geotechnical issue impacting proposed site development is the continued settlement of the landfill material. Haley & Aldrich noted that the Final Design Report for the landfill estimated that the landfill could experience approximately 1 to 3 feet of “primary” settlement within 3 to 6 months following regrading of the landfill and placement of 4 ft. of additional soil cover and approximately 1.5 to 2.5 ft. of long-term settlement due to long term creep and waste decomposition over 10 to 50 years. Haley & Aldrich also noted that differential settlements on the order of 25 to 75 percent of the total settlements are common for landfills like the Gardena landfill. Since the Gardena landfill appears to be relatively uniform depth wise, the differential settlement would most likely be most significant near the limits of waste such as is visible along the southern edge of the parking lot at the subject site.

#### Utilities

It is anticipated that, due to the likelihood of significant settlement of the site surface due to consolidation and decomposition of the landfill materials, the gravity flow utilities, such as sewer and storm drain pipes will also have to be pile supported. Other utility lines, such as water, gas, and electric lines may either be pile supported or designed with sufficient flexibility to accept several feet of differential settlement over a period of time.

### Paving

The presence of the landfill materials, which will continue to consolidate and/or decompose over time will result in short pavement life and the need to provide regular maintenance. Hinged approach aprons/ramps should be provided at vehicle drive lanes approaching loading docks, designed to accommodate future differential settlement of the surrounding ground relative to the pile supported structures, over areas of landfill.

### Flatwork

Hardscape slabs and sidewalks may be founded on the surficial 6 to 7 foot thick fill layer overlying the landfill material, but consideration should be given to supporting sidewalks immediately adjacent to the buildings on piles or as structural slabs supported on the building edge and “hinged” to allow settlement of the outer edge away from the building.

### Site Development Recommendations

#### General

During earthwork construction, all site preparation and the general procedures of the contractor should be observed, and the fill selectively tested by a representative of TGR. If unusual or unexpected conditions are exposed in the field, they should be reviewed by this office and if warranted, modified and/or additional recommendations will be offered. During demolition of the existing building and associated site work, voids created from removal of buried elements (footings, pipelines, septic pits etc) shall be backfilled with engineered fill (min 90% relative compaction per ASTM D1557) under the observation of TGR.

#### Grading

All grading should conform to the guidelines presented in the 2019 California Building, except where specifically superseded in the text of this report. Prior to grading, TGR’s representative should be present at the pre-construction meeting to provide grading guidelines, if needed, and review any earthwork.

All pavement areas around the pile supported buildings shall be compacted to a minimum 90 percent relative compaction at least 2 feet below existing or finish grade, whichever is lower. The existing soil may be used as engineered fill provided it is free of trash, debris, deleterious materials, and particles greater than 4-inches. The fill should be moistened to near optimum moisture content and compacted to a minimum of 90 percent relative compaction and verified by our representative. A layer of bi-axial geogrid, Tensar BX 1100 or equivalent, may be considered to help reduce future pavement settlement. More specific details can be provided upon request.

The depth of over-excavation should be reviewed by the Geotechnical Consultant during the actual construction. Any subsurface obstruction buried structural elements, and unsuitable material encountered during grading, should be immediately brought to the attention of the Geotechnical Consultant for proper exposure, removal and processing, as recommended.

### Fill Placement

Prior to any fill placement TGR should observe the exposed surface soils. The site soils may be re-used as engineered fill provided they are free of organic content and particle size greater than 4-inches. All particles greater than 4-inches shall be removed and disposed offsite. Fill shall be moisture-conditioned to near optimum moisture content for onsite soils and compacted to a minimum relative compaction of 90 percent in accordance with ASTM D1557. Any import soils shall be non-expansive and approved by TGR Geotechnical Inc.

### Compaction

Prior to fill placement, the exposed surface should be scarified to a minimum depth of eight (8) inches, fill placed in six (6) inch thick loose lifts, moisture conditioned to near optimum moisture content, and compacted to a minimum relative compaction of ninety (90) percent in accordance with ASTM D1557.

### Trenching

All excavations should conform to CAL-OSHA and local safety codes.

### Temporary Excavation

Temporary construction excavations are anticipated during the proposed development. Excavations/cuts should be properly shored or sloped back to at least 1H:1V (Horizontal: Vertical) or flatter. The exposed slope face should be kept moist (but not saturated) during construction to reduce local sloughing. No surcharge loads should be permitted within a horizontal distance equal to the height of cut from the toe of excavation unless the cut is properly shored. Excavations that extend below an imaginary plane inclined at 45 degrees below the edge of any nearby adjacent existing site facilities should be properly shored to maintain foundation support at the adjacent structures.

### Drainage

Positive site drainage should be maintained at all times. Water should be directed away from foundations and not allowed to pond and/or seep into the ground. Pad drainage should be directed towards street/parking or other approved area.

### Utility Trench Backfill

All utility trench backfills in structural areas and beneath hardscape features should be brought to near optimum moisture content and compacted to a minimum relative compaction of 90 percent of the laboratory standard. Flooding/jetting is not recommended.

Sand backfill, (unless trench excavation material), should not be allowed in parallel exterior trenches adjacent to and within an area extending below a 1:1 plane projected from the outside bottom edge of the footing. All trench excavations should minimally conform to CAL-OSHA and local safety codes. Soils generated from utility trench excavations may be used provided it is moisture conditioned and compacted to 90 percent minimum relative compaction.

### Preliminary Pavement Design

The Caltrans method of design was utilized to develop the following asphalt pavement section. The section was developed based on tested "R-Value" for compacted site subgrade soils of 9 (Coleman, 2004).

Traffic indices of 4.5, 5, 6, and 7 were assumed for use in the evaluation of automobile parking stalls and driveways, and medium and heavy truck driveways, respectively. The traffic indices are subject to approval by controlling authorities and shall be approved by the project civil engineer.

ASPHALT PAVEMENT SECTION					PCC PAVEMENT SECTION		
Pavement Utilization	Traffic Index	Asphalt (Inch)	Aggregate Base (Inch)	Total (Inch)	*PCC	Aggregate Base (Inch)	Total (Inch)
Parking Stalls	4.5	3.5	7.0	10.5	--	--	--
Auto Driveways	5.0	4.0	8.0	12.0	--	--	--
Truck Aisles/ Driveways	6.0	5.0	10.0	15.0	7.5	6.0	13.5
Loading Dock	7.0	6.0	12.0	18.0	8.0	6.0	14.0

\*Minimum concrete compressive strength of 3,000 psi.

\*\* Shall also comply with City requirements

Aggregate base material should consist of CAB/CMB complying with the specifications in Section 200.2. of the current "Standard Specifications for Public Works Construction" and should be compacted to at least ninety-five (95) percent of the maximum dry density (ASTM D1557). The surface of the aggregate base should exhibit a firm and unyielding condition just prior to the placement of asphalt concrete paving.

The pavement subgrade should be constructed in accordance with the recommendations presented in the grading section of this report.

The R-value and the associated pavement section should be confirmed at the completion of site grading.

An increase in the PCC pavement slab thickness, placement of steel reinforcement (or other alternatives such as Fibermesh) and joint spacing due to loading conditions including shrinkage and thermal effects may be necessary and should be incorporated by the structural engineer as necessary to prevent adverse impact on pavement performance and maintenance.

### Geotechnical Review of Plans

All grading and foundation plans should be reviewed and accepted by the geotechnical consultant prior to construction. If significant time elapses since preparation of this report, the geotechnical consultant should verify the current site conditions, and provide any additional recommendations (if necessary) prior to construction.

### Geotechnical Observation/Testing During Construction

Per sections 1705.6 and table 1705.6 of the 2019 California Building Code, periodic special inspection shall be performed to:

- Verify materials below shallow foundations are adequate to achieve the design bearing capacity;
- Verify excavations are extended to the proper depth and have reached proper material;
- Verify classification and test compacted materials; and
- Prior to placement of compacted fill, inspect subgrade and verify that the site has been prepared properly

Per sections 1705.6 and table 1705.6 of the 2019 California Building Code, continuous special inspection shall be performed to:

- Verify use of proper materials, densities and lift thickness during placement and compaction of compacted fill.

The geotechnical consultant should perform observation and/or testing at the following stages:

- During any grading and fill placement;
- Prior to pouring foundation or flatwork concrete;
- During trench excavation;
- Excavation bottom;
- Placement of bedding material;
- During trench backfill;
- Subgrade for flatwork;
- When any unusual soil conditions are encountered during any construction operation subsequent to issuance of this report.

### Limitations

This report was prepared for a specific client and a specific project, based on the client's needs, directions and requirements at the time.

This report was necessarily based upon data obtained from a limited number of observances, site visits, soil and/or other samples, tests, analyses, histories of occurrences, spaced subsurface exploration and limited information on historical events and observations. Such information is necessarily incomplete. Variations can be experienced within small distances and under various climatic conditions. Changes in subsurface conditions can and do occur over time.

This report is not authorized for use by and is not to be relied upon by any party except the client with whom TGR contracted for the work. Use or reliance on this report by any other party

is that party's sole risk. Unauthorized use of or reliance on this report constitutes an agreement to defend and indemnify TGR from and against any liability which may arise as a result of such use or reliance, regardless of any fault, negligence, or strict liability of TGR.

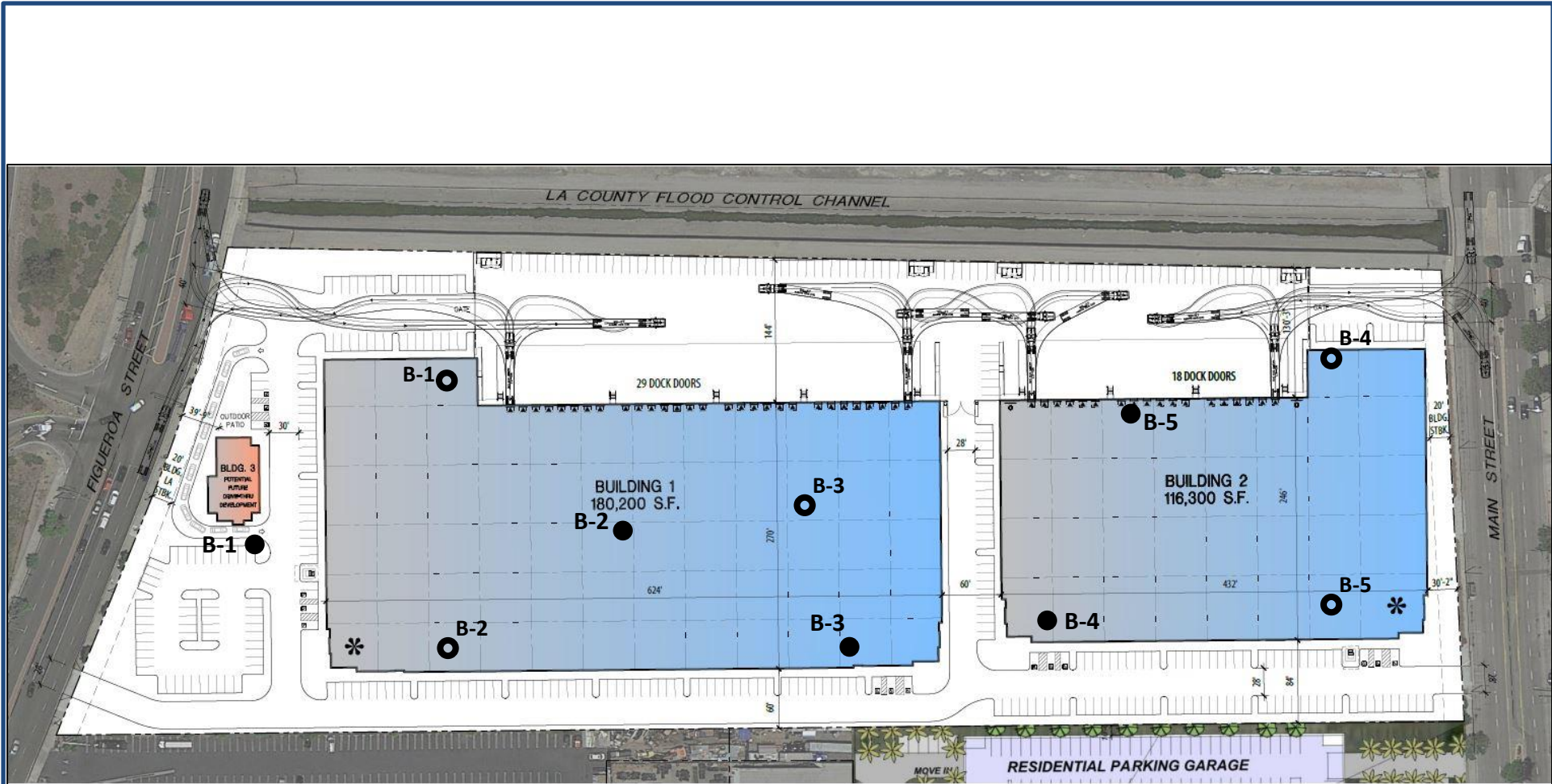

● B-5 APPROXIMATE LOCATION OF EXPLORATORY BORING BY TGR

○ B-5 APPROXIMATE LOCATION OF EXPLORATORY BORING BY COLEMAN GEOTECHNICAL (2004)



BORING LOCATION MAP  
 FIGUEROA STREET BUSINESS PARK  
 CARSON, CALIFORNIA

PROJECT NO. 20-7176

PLATE 1



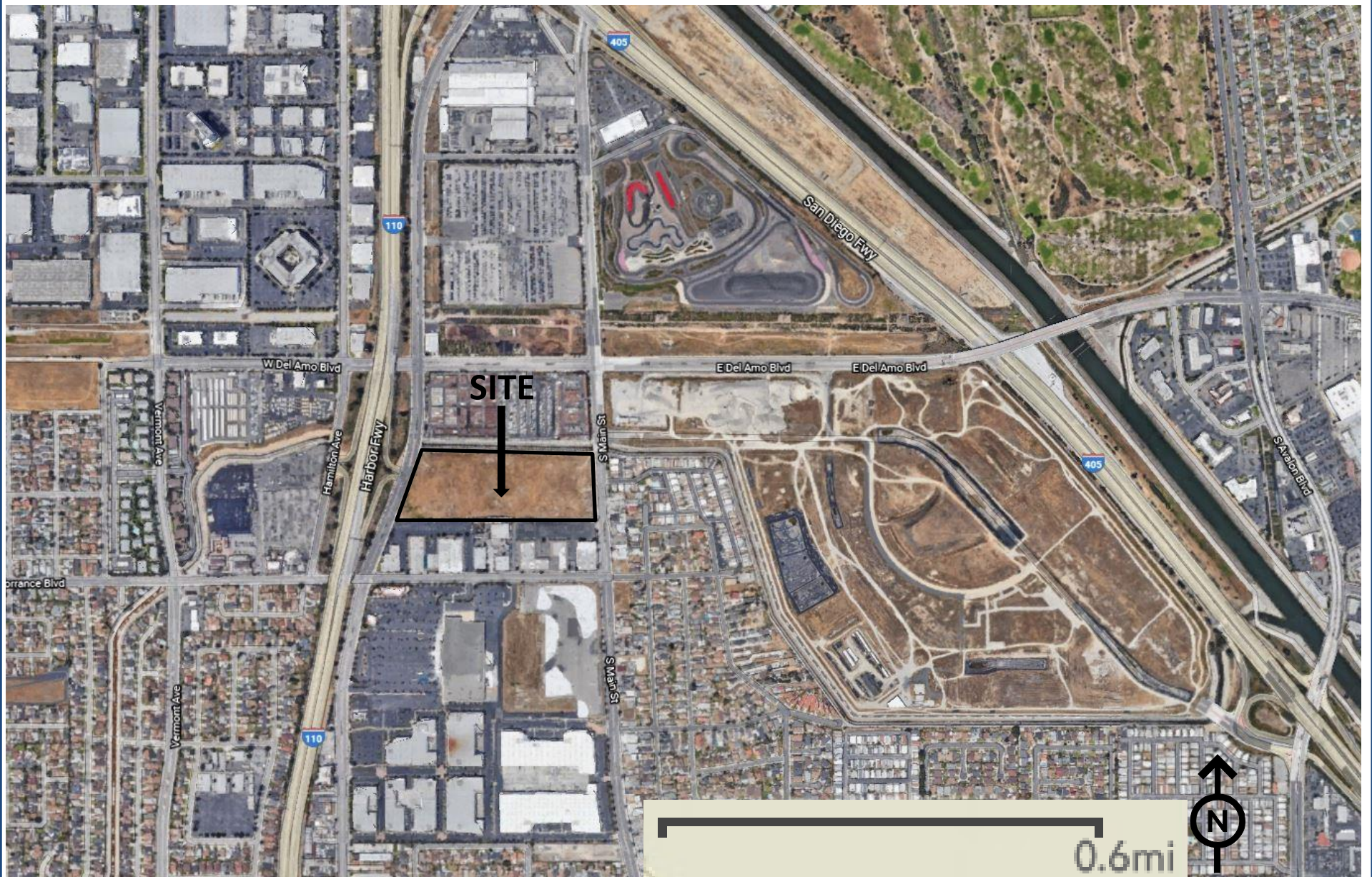

af	
Qs	Qa
Qds	Qae

**SURFICIAL SEDIMENTS**

- af** Artificial fill or cut and fill; many areas may not be shown
- Qs** Beach sediments, ranging from sand to cobble-boulder gravel
- Qds** Loose dune and drift sand
- Qa** Alluvium, mostly loamy clay of valley and flood plains; includes fine sand near Palos Verdes Hills
- Qae** Alluvium, similar to **Qa** but slightly elevated and locally dissected

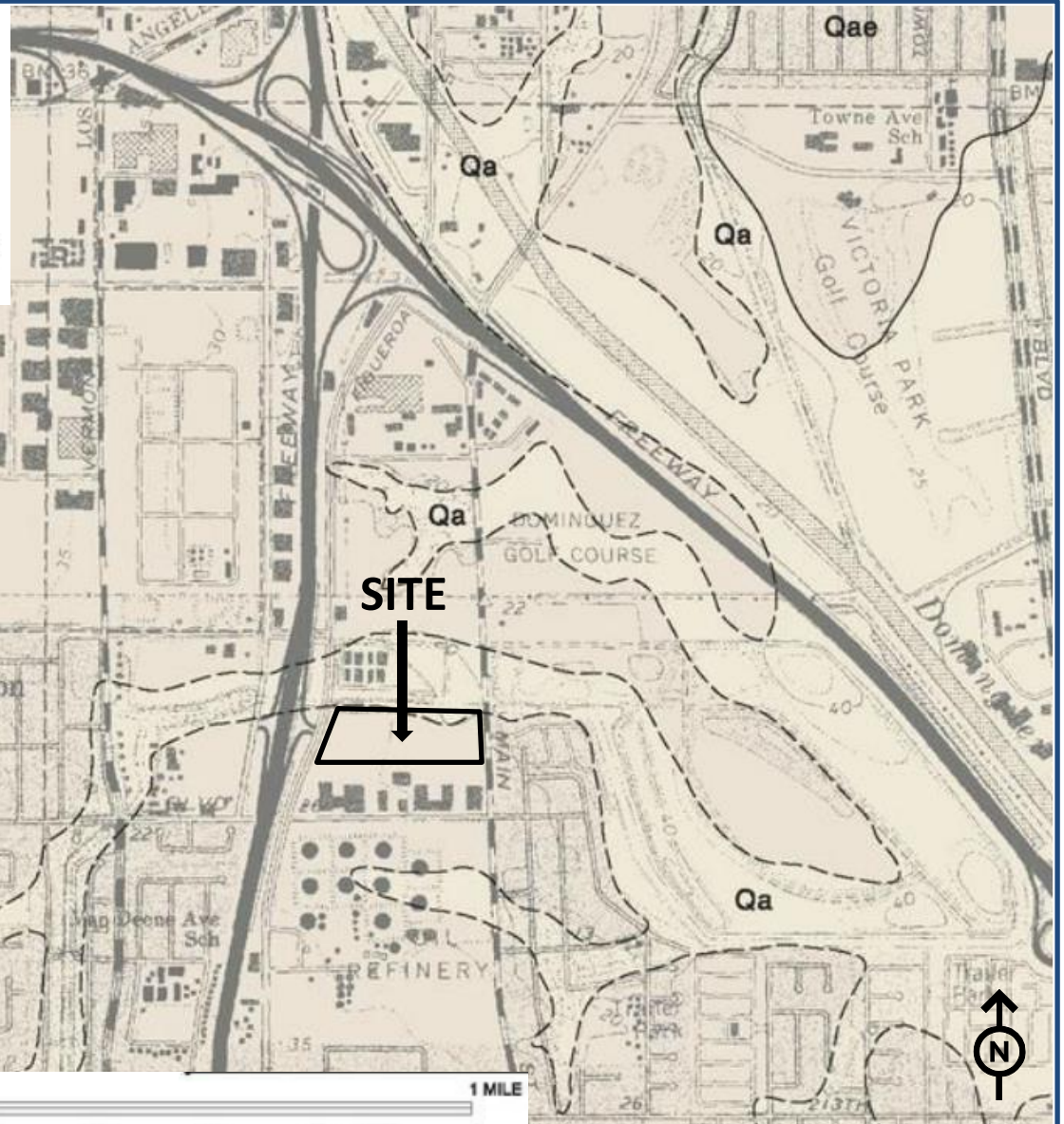

Modified From: Dibblee, T.W., and Ehrenspeck, H.E., ed., 1999, Geologic Map of the Palos Verdes Peninsula and vicinity, Redondo Beach, Torrance, and San Pedro Quadrangles, Los Angeles County, California: Dibblee Geological Foundation Map DF-70, scale 1:24,000.



**REGIONAL GEOLOGY MAP**  
**FIGUEROA STREET BUSINESS PARK**  
**CARSON, CALIFORNIA**

PROJECT NO. 20-7176

**FIGURE 2**

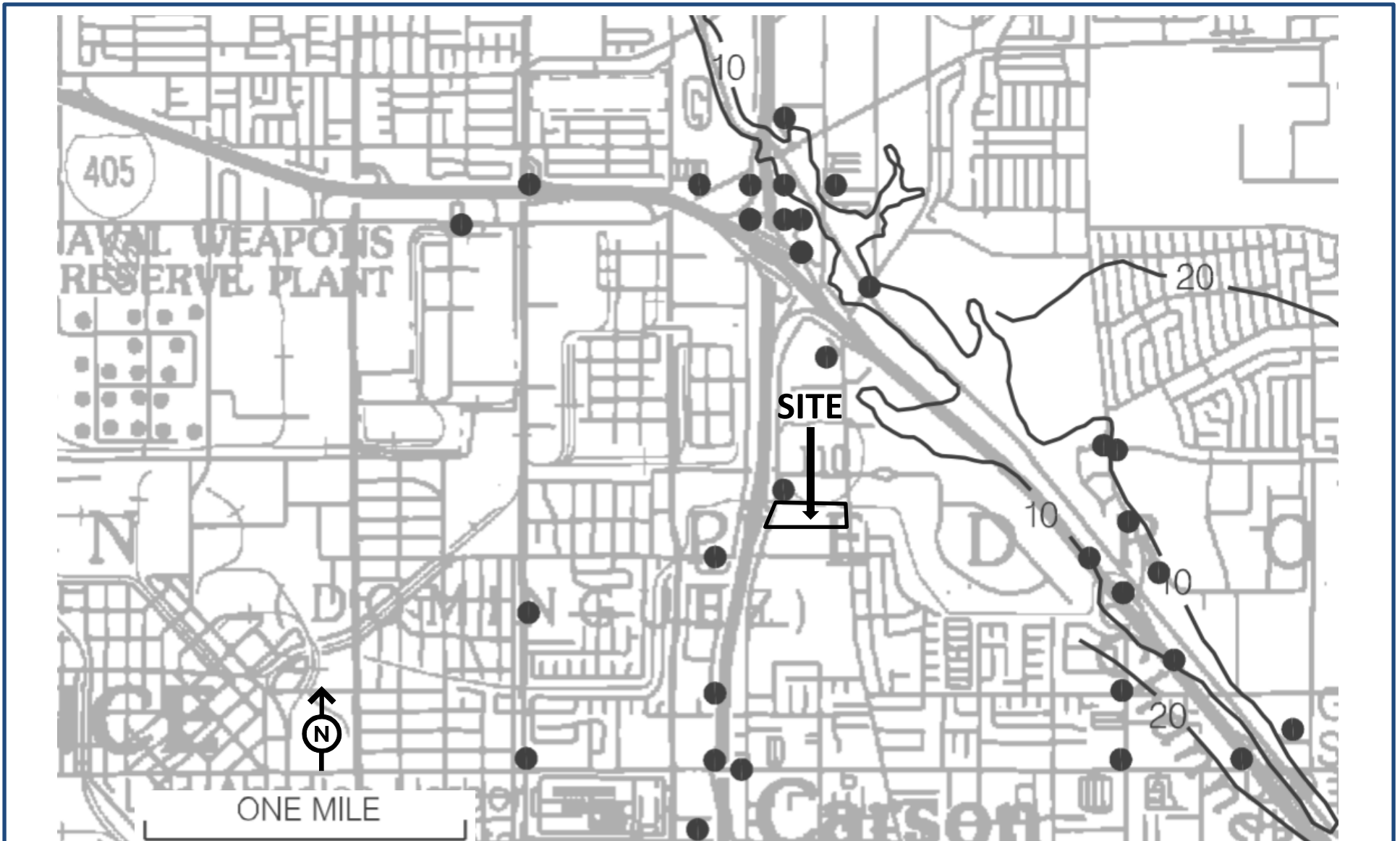

Modified From: California Department of Conservation, Division of Mines and Geology, 1998, Seismic Hazard Zone Report for the Torrance 7.5-Minute Quadrangle, Los Angeles County, California, Seismic Hazard Zone Report 035.

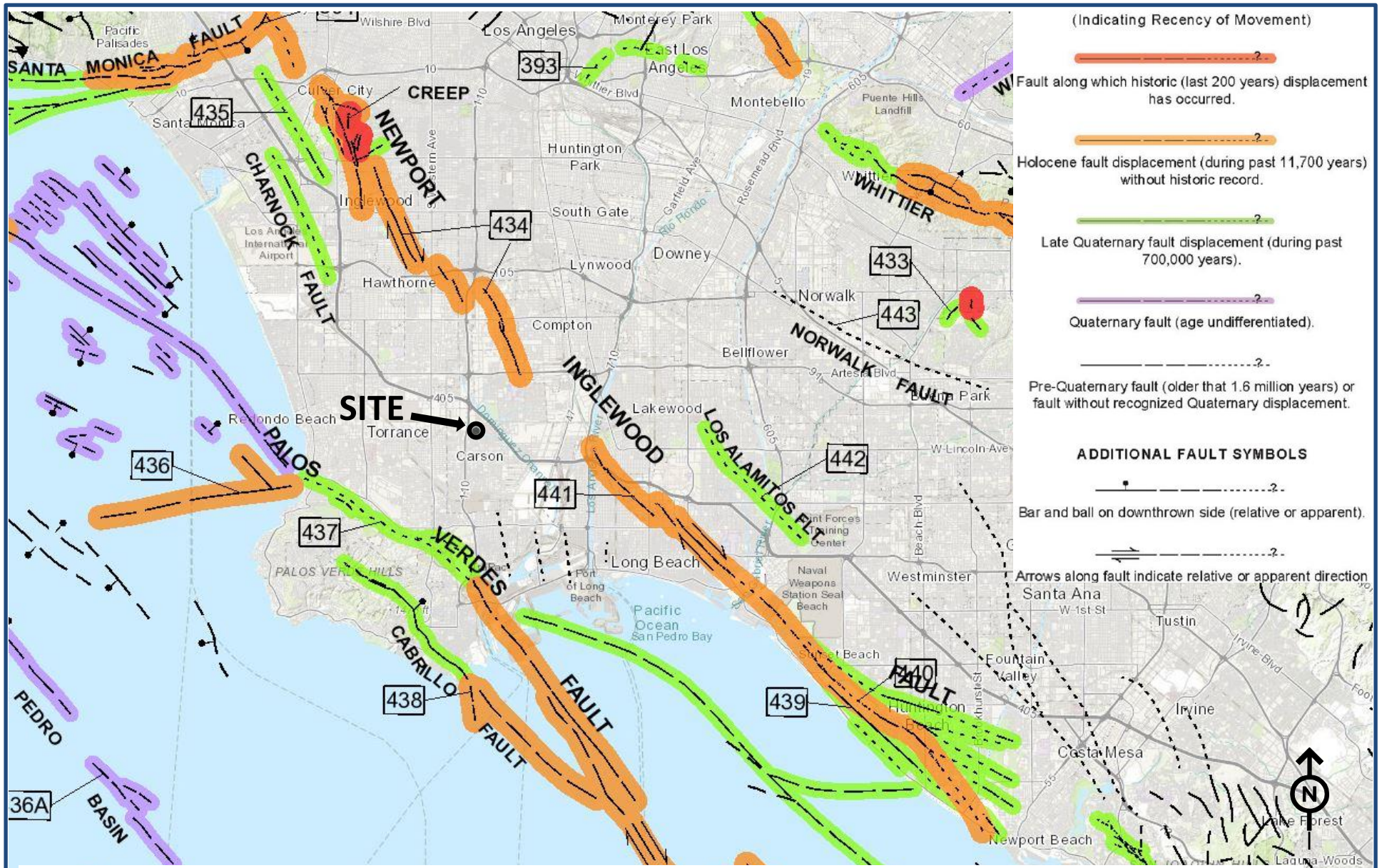

Modified From: Jennings, C. W., 2010, Fault Activity Map of California and Adjacent Areas, California Division of Mines and Geology, Geologic Data Map Series, No. 6, Scale 1:750,000.



REGIONAL FAULT MAP  
 FIGUEROA STREET BUSINESS PARK  
 CARSON, CALIFORNIA

PROJECT NO. 20-7176

FIGURE 4

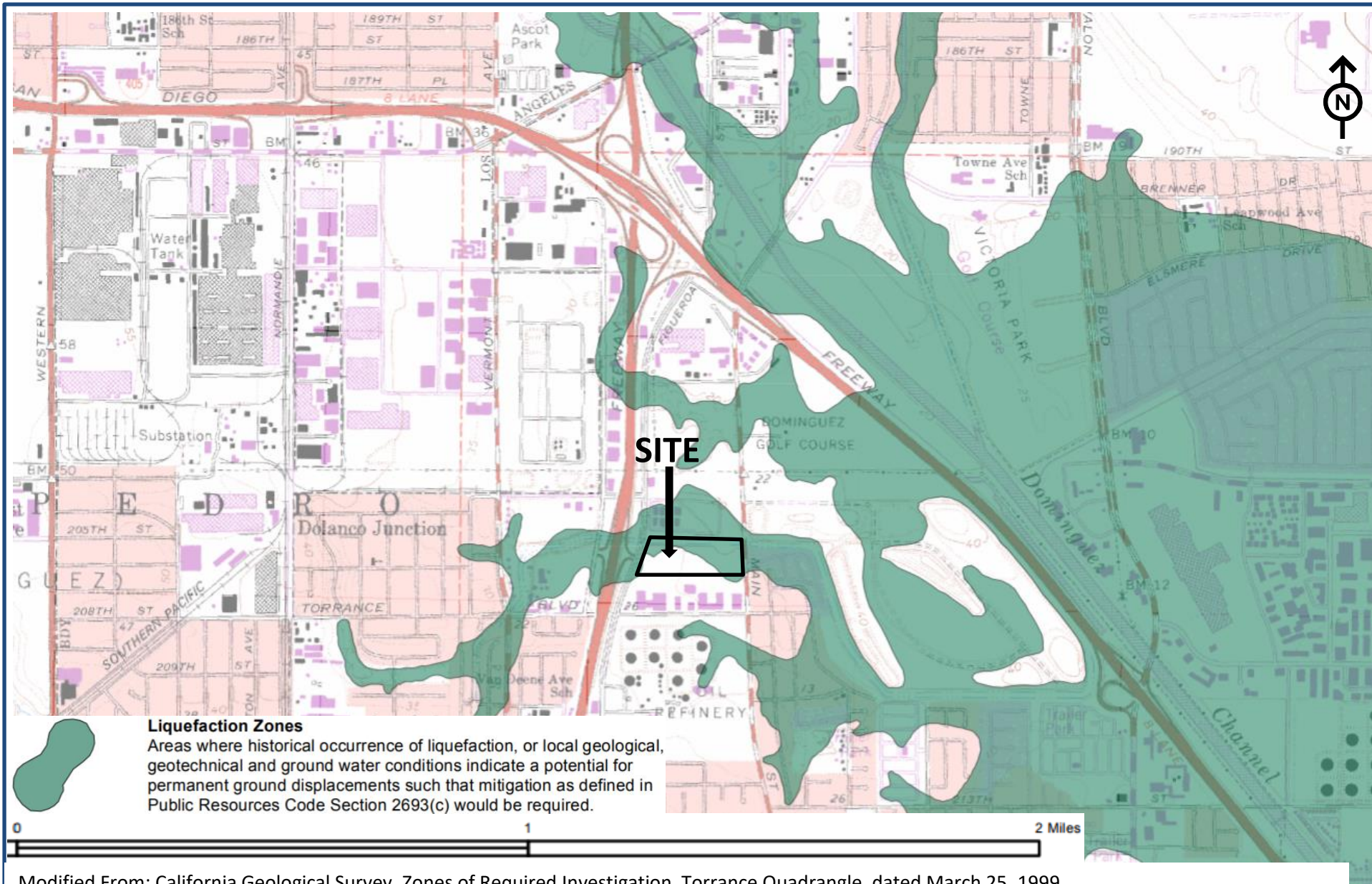

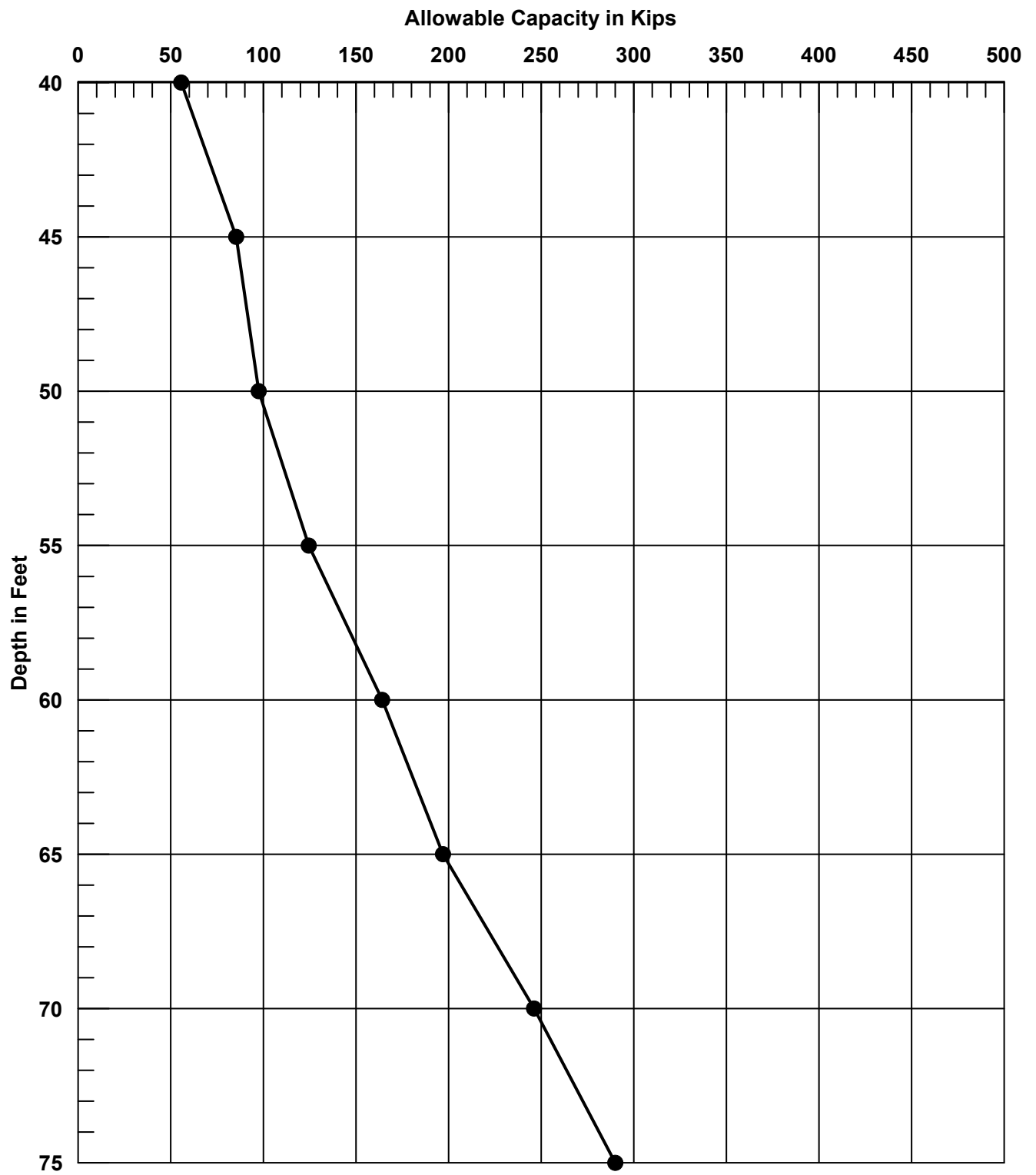

**LEGEND**

● — ● — ● 16 Inch Square Driven (Factor of Safety = 1.5)

**APPENDIX A  
REFERENCES**

## APPENDIX A

### References

- California, State of, Department of Conservation, Division of Mines and Geology, 2008, Guidelines for Evaluating and Mitigating Seismic Hazards in California, CDMG Special Publication 117A.
- California Department of Conservation, Division of Mines and Geology, 1998, Seismic Hazard Zone Report for the Torrance 7.5-Minute Quadrangle, Los Angeles County, California, Seismic Hazard Zone Report 035.
- \_\_\_\_\_, 1998, Maps of Known Active Fault Near – Source Zones in California and Adjacent Portions of Nevada.
- California Geological Survey, 1999, Earthquake Zones of Required Investigation, Torrance Quadrangle, dated March 25, 1999.
- Dibblee, T.W., and Ehrenspeck, H.E., ed., 1999, Geologic Map of the Palos Verdes Peninsula and vicinity, Redondo Beach, Torrance, and San Pedro Quadrangles, Los Angeles County, California: Dibblee Geological Foundation Map #DF-70, scale 1:24,000.
- Hart, E. W., 1997, Fault-Rupture Hazard Zones in California, Alquist-Priolo Earthquake Fault Zoning with Index to Special Study Zones Maps: Department of Conservation, Division of Mines and Geology, Special Publication 42.
- International Code Council (ICC), California Building Code, 2016 Edition
- Jennings, C. W., 2010, Fault Activity Map of California and Adjacent Areas, California Division of Mines and Geology, Geologic Data Map Series, No. 6, Scale 1:750,000.
- Bryan A. Stirrat & Associates, 1993, Draft Remedial Investigation Report, Groundwater Operable Unit for a Portion of the Garden Valley 1 & 2 Landfill, Job No. 90103-8800, dated May 1993
- Coleman Geotechnical, 2004, Geotechnical Investigation, Carson Valley Mixed Use Project, East Side of Figueroa St., About 350 Feet North of Torrance Blvd., Caron, CA, Job. No. 2336, dated May 14, 2004
- GAA Architects, Conceptual Site Plan – Scheme C.3, Figueroa Street Business Park, Carson, California, Project No. XBC048.01, dated 1/4/2021
- Haley & Aldrich, 2005, Geotechnical Feasibility Evaluation, Gardena Valley Landfill 1 and 2 Property, Carson City, California, File No. 32143-001, dated 12 July 2005



**APPENDIX B  
LOG OF BORINGS  
(TGR AND COLEMAN GEOTECHNICAL)**

THE FOLLOWING DESCRIBES THE TERMS AND SYMBOLS USED ON THE LOG  
OF BORINGS TO SUMMARIZE THE RESULTS OBTAINED IN THE FIELD  
INVESTIGATION AND SUBSEQUENT LABORATORY TESTING

**DENSITY AND CONSISTENCY**

The consistency of fine grained soils and the density of coarse grained soils are described on the basis of the Standard Penetration Test as follows:

COARSE GRAINED SOILS	ESTIMATED UNCONFINED COMPRESSIVE STRENGTH (Tsf)	FINE GRAINED SOILS
Very Loose < 4	< 0.25	Very Soft < 2
Loose 4 – 10	0.35 – 0.50	Soft 2 – 4
Medium 10 – 30	0.50 – 1.0	Firm (Medium) 4 – 8
Dense 30 – 50	1.0 – 2.0	Stiff 8 – 15
Very Dense > 50	2.0 – 4.0	Very Stiff 15 – 30
	> 4.0	Hard > 30

**PARTICLE SIZE DEFINITION (As per ASTM D2487 and D422)**

Boulder ⇒ Larger than 12 inches	Coarse Sands ⇒ No. 10 to No. 4 sieve
Cobbles ⇒ 3 to 12 inches	Medium Sands ⇒ No. 40 to No. 10 sieve
Coarse Gravel ⇒ 3/4 to 3 inches	Fine Sands ⇒ No. 200 to 40 sieve
Fine Gravel ⇒ No. 4 to 3/4 inches	Silt ⇒ 5µm to No. 200 sieve
	Clay ⇒ Smaller than 5µm

**SOIL CLASSIFICATION**

Soils and bedrock are classified and described based on their engineering properties and characteristics using ASTM D2487 and D2488.

Percentage description of minor components:

Trace 1 – 10%	Some 20 – 35%
Little 10 – 20%	And or y 25 – 50%

Stratified soils description:

Parting 0 to 1/16 inch thick	Layer ½ to 12 inches thick
Seam 1/16 to ½ inch thick	Stratum > 12 inches thick

# SOIL CLASSIFICATION CHART

UNIFIED SOIL CLASSIFICATION AND SYMBOL CHART		
<b>COARSE-GRAINED SOILS</b> (more than 50% of material is larger than No. 200 sieve size.)		
Clean Gravels (Less than 5% fines)		
<b>GRAVELS</b> More than 50% of coarse fraction larger than No. 4 sieve size	GW	Well-graded gravels, gravel-sand mixtures, little or no fines
	GP	Poorly-graded gravels, gravel-sand mixtures, little or no fines
	Gravels with fines (More than 12% fines)	
	GM	Silty gravels, gravel-sand-silt mixtures
	GC	Clayey gravels, gravel-sand-clay mixtures
Clean Sands (Less than 5% fines)		
<b>SANDS</b> 50% or more of coarse fraction smaller than No. 4 sieve size	SW	Well-graded sands, gravelly sands, little or no fines
	SP	Poorly graded sands, gravelly sands, little or no fines
	Sands with fines (More than 12% fines)	
	SM	Silty sands, sand-silt mixtures
	SC	Clayey sands, sand-clay mixtures
<b>FINE-GRAINED SOILS</b> (50% or more of material is smaller than No. 200 sieve size.)		
<b>SILTS AND CLAYS</b> Liquid limit less than 50%	ML	Inorganic silts and very fine sands, rock flour, silty of clayey fine sands or clayey silts with slight plasticity
	CL	Inorganic clays of low to medium plasticity, gravelly clays, sandy clays, silty clays, lean clays
	OL	Organic silts and organic silty clays of low plasticity
<b>SILTS AND CLAYS</b> Liquid limit 50% or greater	MH	Inorganic silts, micaceous or diatomaceous fine sandy or silty soils, elastic silts
	CH	Inorganic clays of high plasticity, fat clays
	OH	Organic clays of medium to high plasticity, organic silts
<b>HIGHLY ORGANIC SOILS</b>	PT	Peat and other highly organic soils

LABORATORY CLASSIFICATION CRITERIA		
GW	$C_u = \frac{D_{60}}{D_{10}}$ greater than 4; $C_c = \frac{D_{30}}{D_{10} \times D_{60}}$ between 1 and 3	
GP	Not meeting all gradation requirements for GW	
GM	Atterberg limits below "A" line or P.I. less than 4	Above "A" line with P.I. between 4 and 7 are borderline cases requiring use of dual symbols
GC	Atterberg limits above "A" line with P.I. greater than 7	
SW	$C_u = \frac{D_{60}}{D_{10}}$ greater than 4; $C_c = \frac{D_{30}}{D_{10} \times D_{60}}$ between 1 and 3	
SP	Not meeting all gradation requirements for GW	
SM	Atterberg limits below "A" line or P.I. less than 4	Limits plotting in shaded zone with P.I. between 4 and 7 are borderline cases requiring use of dual symbols.
SC	Atterberg limits above "A" line with P.I. greater than 7	

Determine percentages of sand and gravel from grain-size curve. Depending on percentage of fines (fraction smaller than No. 200 sieve size), coarse-grained soils are classified as follows:

Less than 5 percent ..... GW, GP, SW, SP  
 More than 12 percent ..... GM, GC, SM, SC  
 5 to 12 percent ..... Borderline cases requiring dual symbols

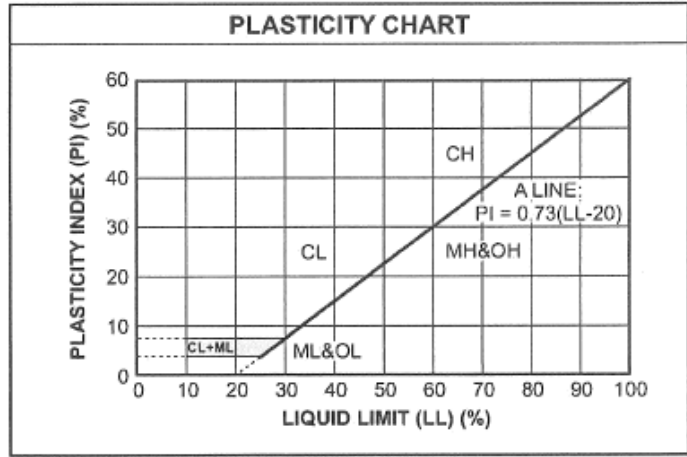

## PARTICLE SIZE LIMITS





COBBLES	GRAVEL		SAND			SILT OR CLAY
	coarse	fine	coarse	medium	fine	
	3"	¾"	NO. 4	NO. 10	NO. 40	NO. 200

# LOG OF EXPLORATORY BORING B-1

Sheet 1 of 3

Project Number: **20-7176**  
 Project Name: **Figueroa Street Business Park, Carson**  
 Date Drilled: **1/22/21**  
 Ground Elev: \_\_\_\_\_

Logged By: **PK**  
 Project Engineer: **SG**  
 Drill Type: **Hollow Stem**  
 Drive Wt & Drop: **140lbs / 30in**

Depth (ft)	Graphic Log	FIELD RESULTS					LAB RESULTS		
		Bulk Sample	Drive Sample	SPT blows/ft (or equivalent N)	Pocket Pen (tsf)	USCS	Moisture Content (%)	Dry Density, (pcf)	Other Tests
						 Shelby Tube  Standard Split Spoon  No recovery			
						 Modified California  Water Table ATD			
SUMMARY OF SUBSURFACE CONDITIONS									

5	10	15	20	25		<p>Soil Cover: Silt- reddish brown to dark grayish brown with depth</p> <hr/> <p>Landfill Material- greenish gray, primarily wood, plastics, fabrics, metals, paper. No samples taken.</p>			
---	----	----	----	----	--	--	--	--	--

LOG OF BORING: 20-7176 XEBEC FIGUEROA.GPJ TGR GEOTECH.GDT 2/16/21

This Boring Log should be evaluated in conjunction with the complete geotechnical report. This Boring Log represents conditions observed at the specific location and date indicated, it is not warranted to be representative of subsurface conditions at other locations and times.

## PLATE 2



# LOG OF EXPLORATORY BORING B-1

Project Number: **20-7176**  
 Project Name: **Figueroa Street Business Park, Carson**  
 Date Drilled: **1/22/21**  
 Ground Elev: \_\_\_\_\_

Logged By: **PK**  
 Project Engineer: **SG**  
 Drill Type: **Hollow Stem**  
 Drive Wt & Drop: **140lbs / 30in**

Depth (ft)	Graphic Log	FIELD RESULTS					LAB RESULTS		
		Bulk Sample	Drive Sample	SPT blows/ft (or equivalent N)	Pocket Pen (tsf)	USCS	Moisture Content (%)	Dry Density, (pcf)	Other Tests
						Shelby Tube Standard Split Spoon No recovery Modified California Water Table ATD			
SUMMARY OF SUBSURFACE CONDITIONS									

35						Landfill Material- greenish gray, primarily wood, plastics, fabrics, metals, paper. No samples taken. <i>(continued)</i>			
40		20	CL	Native: Sandy Clay-grayish brown, very moist, medium stiff			20		
45		31	CL	Sandy Clay to Clay- grayish brown, moist, medium stiff, fine sand			24	108	
50		9	CL	.....same as above, very moist ...seepage			34		
55		21	CL	Clay- grayish brown with orange oxidation, some fine sand, wet, medium stiff			17	118	-200= 57.3%
55		21	CL	Sandy Clay- same as above					

LOG OF BORING: 20-7176 XEBEC FIGUEROA.GPJ TGR GEOTECH.GDT 2/16/21

This Boring Log should be evaluated in conjunction with the complete geotechnical report. This Boring Log represents conditions observed at the specific location and date indicated, it is not warranted to be representative of subsurface conditions at other locations and times.

PLATE 3



# LOG OF EXPLORATORY BORING B-1

Sheet **3** of **3**

Project Number: **20-7176**  
 Project Name: **Figueroa Street Business Park, Carson**  
 Date Drilled: **1/22/21**  
 Ground Elev: \_\_\_\_\_

Logged By: **PK**  
 Project Engineer: **SG**  
 Drill Type: **Hollow Stem**  
 Drive Wt & Drop: **140lbs / 30in**

Depth (ft)	Graphic Log	FIELD RESULTS					LAB RESULTS		
		Bulk Sample	Drive Sample	SPT blows/ft (or equivalent N)	Pocket Pen (tsf)	USCS	Moisture Content (%)	Dry Density, (pcf)	Other Tests
						Shelby Tube Standard Split Spoon No recovery Modified California Water Table ATD			
SUMMARY OF SUBSURFACE CONDITIONS									

65		21	CL	Sandy Clay- grayish to yellowish brown, medium stiff to stiff, wet	21		
70		>50	CL	Clayey Sand- grayish brown with orange oxidation, some silt, medium dense to dense, fine sand, wet	23	104	-200= 36.0%
75		37	ML	Sandy Silt- orange brown, fine sand, medium stiff to stiff, wet	33		-200= 78.5%
75		16	CL	Sandy Clay to Clay- grayish to orange brown, medium stiff to stiff, wet	39		-200= 87.0%
Bottom of Boring at 76.5 feet No caving observed No static groundwater encountered Boring backfilled with bentonite slurry							

LOG OF BORING: 20-7176 XEBEC FIGUEROA.GPJ\_TGR GEOTECH.GDT 2/16/21

This Boring Log should be evaluated in conjunction with the complete geotechnical report. This Boring Log represents conditions observed at the specific location and date indicated, it is not warranted to be representative of subsurface conditions at other locations and times.

PLATE 4



# LOG OF EXPLORATORY BORING B-2

Sheet 1 of 3

Project Number: **20-7176**  
 Project Name: **Figueroa Street Business Park, Carson**  
 Date Drilled: **1/26/21**  
 Ground Elev:

Logged By: **PK**  
 Project Engineer: **SG**  
 Drill Type: **Hollow Stem**  
 Drive Wt & Drop: **140lbs / 30in**

Depth (ft)	Graphic Log	FIELD RESULTS					LAB RESULTS		
		Bulk Sample	Drive Sample	SPT blows/ft (or equivalent N)	Pocket Pen (tsf)	USCS	Moisture Content (%)	Dry Density, (pcf)	Other Tests

Shelby Tube       Standard Split Spoon       No recovery  
 Modified California       Water Table ATD

### SUMMARY OF SUBSURFACE CONDITIONS

Soil Cover: Silt- reddish brown to dark grayish brown with depth

Landfill Material- greenish gray, primarily wood, plastics, fabrics, metals. No samples taken.

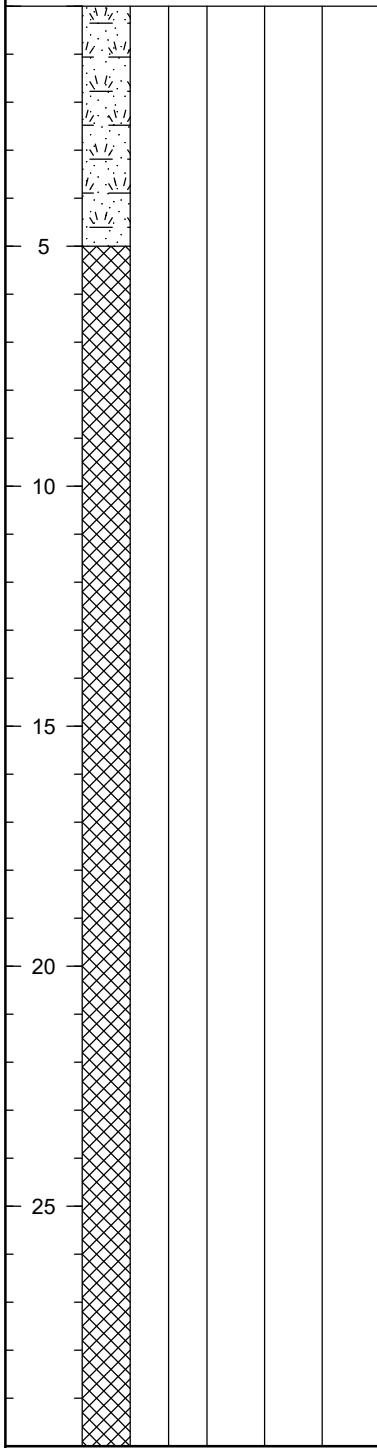

LOG OF BORING 20-7176 XEBEC FIGUEROA.GPJ TGR GEOTECH.GDT 2/16/21

This Boring Log should be evaluated in conjunction with the complete geotechnical report. This Boring Log represents conditions observed at the specific location and date indicated, it is not warranted to be representative of subsurface conditions at other locations and times.

## PLATE 5



# LOG OF EXPLORATORY BORING B-2

Project Number: **20-7176**  
 Project Name: **Figueroa Street Business Park, Carson**  
 Date Drilled: **1/26/21**  
 Ground Elev: \_\_\_\_\_

Logged By: **PK**  
 Project Engineer: **SG**  
 Drill Type: **Hollow Stem**  
 Drive Wt & Drop: **140lbs / 30in**

Depth (ft)	Graphic Log	FIELD RESULTS					LAB RESULTS		
		Bulk Sample	Drive Sample	SPT blows/ft (or equivalent N)	Pocket Pen (tsf)	USCS	Moisture Content (%)	Dry Density, (pcf)	Other Tests
						Shelby Tube Modified California Standard Split Spoon Water Table ATD No recovery			
SUMMARY OF SUBSURFACE CONDITIONS									

35						Landfill Material- greenish gray, primarily wood, plastics, fabrics, metals. No samples taken. <i>(continued)</i>			
		15	CL			Native: Sandy Clay-grayish brown, fine sand, medium stiff to stiff, moist	21		
		18	CL			Sandy Clay- grayish brown, moist, medium stiff, fine sand	17	111	
		16	CL			.....same as above	24		
		22	CL			Sandy Clay to Clay- olive brown with orange oxidation, fine sand, medium stiff to stiff, seepage water, very moist	28	99	
		11	CL			Clay- grayish brown, trace of fine sand, medium stiff, very moist	37		

LOG OF BORING: 20-7176 XEBEC FIGUEROA.GPJ TGR GEOTECH.GDT 2/16/21

This Boring Log should be evaluated in conjunction with the complete geotechnical report. This Boring Log represents conditions observed at the specific location and date indicated, it is not warranted to be representative of subsurface conditions at other locations and times.

## PLATE 6





# LOG OF EXPLORATORY BORING B-2

Sheet **3** of **3**

Project Number: **20-7176**  
 Project Name: **Figueroa Street Business Park, Carson**  
 Date Drilled: **1/26/21**  
 Ground Elev: \_\_\_\_\_

Logged By: **PK**  
 Project Engineer: **SG**  
 Drill Type: **Hollow Stem**  
 Drive Wt & Drop: **140lbs / 30in**

Depth (ft)	Graphic Log	FIELD RESULTS					LAB RESULTS		
		Bulk Sample	Drive Sample	SPT blows/ft (or equivalent N)	Pocket Pen (tsf)	USCS	Moisture Content (%)	Dry Density, (pcf)	Other Tests
<div style="display: flex; justify-content: space-around; align-items: flex-start;"> <div style="text-align: center;">  Shelby Tube   Modified California                 </div> <div style="text-align: center;">  Standard Split Spoon   Water Table ATD                 </div> <div style="text-align: center;">  No recovery                 </div> </div>									
SUMMARY OF SUBSURFACE CONDITIONS									

65		22	CL	Clay- grayish brown, some fine sand, medium stiff to stiff, very moist	22	109	
70		28	CL	Sandy Clay- olive brown to brown, fine sand, some silt, medium stiff to stiff, very moist	22		-200=55.6%
75		32	CL	Silty Sand to Sandy Silt- brown to olive brown with orange oxidation, medium stiff/ dense to stiff, very moist	27		-200=51.2%
		32	SM	Silty Sand- brown, medium dense to dense, very moist	24		-200=22.0%
Bottom of Boring at 76.5 feet No caving observed No static groundwater encountered Boring backfilled with bentonite slurry							

LOG OF BORING: 20-7176 XEBEC FIGUEROA.GPJ\_TGR GEOTECH.GDT 2/16/21

This Boring Log should be evaluated in conjunction with the complete geotechnical report. This Boring Log represents conditions observed at the specific location and date indicated, it is not warranted to be representative of subsurface conditions at other locations and times.

## PLATE 7



# LOG OF EXPLORATORY BORING B-3

Project Number: **20-7176**  
 Project Name: **Figueroa Street Business Park, Carson**  
 Date Drilled: **1/27/21**  
 Ground Elev: \_\_\_\_\_

Logged By: **PK**  
 Project Engineer: **SG**  
 Drill Type: **Hollow Stem**  
 Drive Wt & Drop: **140lbs / 30in**

Depth (ft)	Graphic Log	FIELD RESULTS					LAB RESULTS		
		Bulk Sample	Drive Sample	SPT blows/ft (or equivalent N)	Pocket Pen (tsf)	USCS	Moisture Content (%)	Dry Density, (pcf)	Other Tests
						Shelby Tube Modified California	Standard Split Spoon Water Table ATD	No recovery	
SUMMARY OF SUBSURFACE CONDITIONS									

5	10	15	20	25		<p>Soil Cover: Silt- reddish brown to dark grayish brown with depth</p> <hr/> <p>Landfill Material- greenish gray, primarily wood, plastics, fabrics, metals. No samples taken.</p>			
---	----	----	----	----	--	---	--	--	--

LOG OF BORING: 20-7176 XEBEC FIGUEROA.GPJ TGR GEOTECH.GDT 2/16/21

This Boring Log should be evaluated in conjunction with the complete geotechnical report. This Boring Log represents conditions observed at the specific location and date indicated, it is not warranted to be representative of subsurface conditions at other locations and times.

PLATE 8



# LOG OF EXPLORATORY BORING B-3

Project Number: **20-7176**  
 Project Name: **Figueroa Street Business Park, Carson**  
 Date Drilled: **1/27/21**  
 Ground Elev: \_\_\_\_\_

Logged By: **PK**  
 Project Engineer: **SG**  
 Drill Type: **Hollow Stem**  
 Drive Wt & Drop: **140lbs / 30in**

Depth (ft)	Graphic Log	FIELD RESULTS					LAB RESULTS		
		Bulk Sample	Drive Sample	SPT blows/ft (or equivalent N)	Pocket Pen (tsf)	USCS	Moisture Content (%)	Dry Density, (pcf)	Other Tests
						Shelby Tube Standard Split Spoon No recovery Modified California Water Table ATD			
SUMMARY OF SUBSURFACE CONDITIONS									

35						Landfill Material- greenish gray, primarily wood, plastics, fabrics, metals. No samples taken. <i>(continued)</i>			
			18	CL		Native: Clay- olive brown, medium stiff to stiff, very moist	22	107	
			34	CL		Sandy Clay- olive brown to yellowish brown, stiff, very moist	19		
			33	CL		Sandy Clay to Clay- olive brown with orange oxidation, medium stiff to stiff, very moist .....seepage	24	102	
			11	CL		Clay- same as above	29		
			14	CL		Clay- grayish brown, stiff, very moist	34	87	

LOG OF BORING: 20-7176 XEBEC FIGUEROA.GPJ TGR GEOTECH.GDT 2/16/21

This Boring Log should be evaluated in conjunction with the complete geotechnical report. This Boring Log represents conditions observed at the specific location and date indicated, it is not warranted to be representative of subsurface conditions at other locations and times.

PLATE 9



# LOG OF EXPLORATORY BORING B-3

Sheet **3** of **3**

Project Number: **20-7176**  
 Project Name: **Figueroa Street Business Park, Carson**  
 Date Drilled: **1/27/21**  
 Ground Elev: \_\_\_\_\_

Logged By: **PK**  
 Project Engineer: **SG**  
 Drill Type: **Hollow Stem**  
 Drive Wt & Drop: **140lbs / 30in**

Depth (ft)	Graphic Log	FIELD RESULTS					LAB RESULTS		
		Bulk Sample	Drive Sample	SPT blows/ft (or equivalent N)	Pocket Pen (tsf)	USCS	Moisture Content (%)	Dry Density, (pcf)	Other Tests
<div style="display: flex; justify-content: space-around; align-items: flex-start;"> <div style="text-align: center;">  Shelby Tube   Modified California                 </div> <div style="text-align: center;">  Standard Split Spoon   Water Table ATD                 </div> <div style="text-align: center;">  No recovery                 </div> </div>									
SUMMARY OF SUBSURFACE CONDITIONS									

65	34	CL	Sandy Clay- grayish brown, stiff, very moist	21	-200=67.4%
70	20	CL	Clay- olive brown, some fine sand, medium stiff to stiff, very moist	27	
75	51	CL	Clay- olive brown with orange oxidation, some fine sand, stiff, very moist	30	-200=78.4%
75	39	CL	.....same as above	31	-200=77.9%
Bottom of Boring at 76.5 feet No caving observed No static groundwater encountered Boring backfilled with bentonite slurry					

LOG OF BORING: 20-7176 XEBEC FIGUEROA.GPJ\_TGR GEOTECH.GDT 2/16/21

This Boring Log should be evaluated in conjunction with the complete geotechnical report. This Boring Log represents conditions observed at the specific location and date indicated, it is not warranted to be representative of subsurface conditions at other locations and times.

PLATE 10



# LOG OF EXPLORATORY BORING B-4

Project Number: **20-7176**  
 Project Name: **Figueroa Street Business Park, Carson**  
 Date Drilled: **2/2/21**  
 Ground Elev: \_\_\_\_\_

Logged By: **PK**  
 Project Engineer: **SG**  
 Drill Type: **Hollow Stem**  
 Drive Wt & Drop: **140lbs / 30in**

Depth (ft)	Graphic Log	FIELD RESULTS					LAB RESULTS		
		Bulk Sample	Drive Sample	SPT blows/ft (or equivalent N)	Pocket Pen (tsf)	USCS	Moisture Content (%)	Dry Density (pcf)	Other Tests
						Shelby Tube Standard Split Spoon No recovery Modified California Water Table ATD			
SUMMARY OF SUBSURFACE CONDITIONS									
5	[Graphic Log Pattern]								
						Soil Cover: Silt- reddish brown to dark grayish brown with depth			
						Landfill Material- greenish gray, primarily wood, plastics, fabrics, metals. No samples taken.			
10	[Graphic Log Pattern]								
15	[Graphic Log Pattern]								
20	[Graphic Log Pattern]								
25	[Graphic Log Pattern]								

LOG OF BORING: 20-7176 XEBEC FIGUEROA.GPJ TGR GEOTECH.GDT 2/16/21

This Boring Log should be evaluated in conjunction with the complete geotechnical report. This Boring Log represents conditions observed at the specific location and date indicated, it is not warranted to be representative of subsurface conditions at other locations and times.

## PLATE 11



# LOG OF EXPLORATORY BORING B-4

Project Number: **20-7176**  
 Project Name: **Figueroa Street Business Park, Carson**  
 Date Drilled: **2/2/21**  
 Ground Elev: \_\_\_\_\_

Logged By: **PK**  
 Project Engineer: **SG**  
 Drill Type: **Hollow Stem**  
 Drive Wt & Drop: **140lbs / 30in**

Depth (ft)	Graphic Log	FIELD RESULTS					LAB RESULTS		
		Bulk Sample	Drive Sample	SPT blows/ft (or equivalent N)	Pocket Pen (tsf)	USCS	Moisture Content (%)	Dry Density, (pcf)	Other Tests
						Shelby Tube Standard Split Spoon No recovery Modified California Water Table ATD			
SUMMARY OF SUBSURFACE CONDITIONS									

35						Landfill Material- greenish gray, primarily wood, plastics, fabrics, metals. No samples taken. <i>(continued)</i>			
35		20	CL	Native: Clayey Sand to Sandy Clay- grayish brown, some silt, fine sand, medium stiff to stiff, moist			24	99	
40		15	CL	Clay- grayish brown, trace of fine sand, medium stiff to stiff, moist			21		
45		27	CL	Clay- olive brown, trace of fine sand, stiff, very moist .....seepage water			24	105	
50		11	CL	.....same as above, olive brown with orange oxidation			30		-200= 81.9%
55		16	SM	Sandy silt to silty sand- grayish brown, fine sand, medium dense, wet			24	104	-200= 41.6%

LOG OF BORING: 20-7176 XEBEC FIGUEROA.GPJ TGR GEOTECH.GDT 2/16/21

This Boring Log should be evaluated in conjunction with the complete geotechnical report. This Boring Log represents conditions observed at the specific location and date indicated, it is not warranted to be representative of subsurface conditions at other locations and times.

PLATE 12



# LOG OF EXPLORATORY BORING B-4

Sheet 3 of 3

Project Number: **20-7176**  
 Project Name: **Figueroa Street Business Park, Carson**  
 Date Drilled: **2/2/21**  
 Ground Elev: \_\_\_\_\_

Logged By: **PK**  
 Project Engineer: **SG**  
 Drill Type: **Hollow Stem**  
 Drive Wt & Drop: **140lbs / 30in**

Depth (ft)	Graphic Log	FIELD RESULTS					LAB RESULTS		
		Bulk Sample	Drive Sample	SPT blows/ft (or equivalent N)	Pocket Pen (tsf)	USCS	Moisture Content (%)	Dry Density, (pcf)	Other Tests
<div style="display: flex; justify-content: space-around; align-items: flex-start;"> <div style="text-align: center;">  Shelby Tube   Modified California                 </div> <div style="text-align: center;">  Standard Split Spoon   Water Table ATD                 </div> <div style="text-align: center;">  No recovery                 </div> </div>									
SUMMARY OF SUBSURFACE CONDITIONS									

65	32	CL	Clay- grayish brown to olive brown, stiff to very stiff, wet	31	-200=76.1%
70	31	SC	Clayey sand- olive brown, medium dense to dense, very moist	19	-200=30.0%
75	33	CL	Clay- olive brown with orange oxidation, very stiff, very moist	27	
75	51	CL	Clay- olive brown with orange oxidation, very stiff, moist	29	
Bottom of Boring at 76.5 feet No caving observed No static groundwater encountered Boring backfilled with bentonite slurry					

LOG OF BORING: 20-7176 XEBEC FIGUEROA.GPJ\_TGR GEOTECH.GDT 2/16/21

This Boring Log should be evaluated in conjunction with the complete geotechnical report. This Boring Log represents conditions observed at the specific location and date indicated, it is not warranted to be representative of subsurface conditions at other locations and times.

PLATE 13







# LOG OF EXPLORATORY BORING B-5

Sheet 2 of 3

Project Number: **20-7176**  
 Project Name: **Figueroa Street Business Park, Carson**  
 Date Drilled: **1/21/21**  
 Ground Elev: \_\_\_\_\_

Logged By: **PK**  
 Project Engineer: **SG**  
 Drill Type: **Hollow Stem**  
 Drive Wt & Drop: **140lbs / 30in**

Depth (ft)	Graphic Log	FIELD RESULTS				LAB RESULTS		
		Bulk Sample	Drive Sample	SPT blows/ft (or equivalent N)	Pocket Pen (tsf)	USCS	Moisture Content (%)	Dry Density, (pcf)
<div style="display: flex; justify-content: space-around;"> <div style="text-align: center;">  Shelby Tube                 </div> <div style="text-align: center;">  Standard Split Spoon                 </div> <div style="text-align: center;">  No recovery                 </div> </div> <div style="display: flex; justify-content: space-around; margin-top: 5px;"> <div style="text-align: center;">  Modified California                 </div> <div style="text-align: center;">  Water Table ATD                 </div> </div>						SUMMARY OF SUBSURFACE CONDITIONS		

35						Landfill Material- greenish gray, primarily wood, plastics, fabrics, metals, paper. No samples taken. <i>(continued)</i>			
		10	CL			Native: Clayey Sand to Sandy Clay-grayish brown with orange oxidation, very moist, medium stiff	34 28	90 97	Shear, -200= 60.8% LL= 34, PL=16.2
		10	CL			Sandy Clay- grayish brown to brown, fine sand, moist, medium stiff to stiff	19		-200= 61.2% LL= 32, PL= 7.6
		10	CL			.....same as above- olive brown, very moist to wet .....seepage	25	104	Shear
		7	CL			Sandy Clay to Clay- grayish brown, medium stiff, very moist, fine sand	26		-200= 69% LL= 28, PL= 23
		7	SP			Sand- grayish brown, trace of clay, fine to medium, loose to medium dense, wet	23		-200= 11.3% , SO4

LOG OF BORING: 20-7176 XEBEC FIGUEROA.GPJ TGR GEOTECH.GDT 2/16/21

This Boring Log should be evaluated in conjunction with the complete geotechnical report. This Boring Log represents conditions observed at the specific location and date indicated, it is not warranted to be representative of subsurface conditions at other locations and times.

PLATE 15



# LOG OF EXPLORATORY BORING B-5

Project Number: **20-7176**  
 Project Name: **Figueroa Street Business Park, Carson**  
 Date Drilled: **1/21/21**  
 Ground Elev: \_\_\_\_\_

Logged By: **PK**  
 Project Engineer: **SG**  
 Drill Type: **Hollow Stem**  
 Drive Wt & Drop: **140lbs / 30in**

Depth (ft)	Graphic Log	FIELD RESULTS					LAB RESULTS		
		Bulk Sample	Drive Sample	SPT blows/ft (or equivalent N)	Pocket Pen (tsf)	USCS	Moisture Content (%)	Dry Density, (pcf)	Other Tests
		<div style="display: flex; justify-content: space-around;"> <div style="text-align: center;">  Shelby Tube   Modified California                 </div> <div style="text-align: center;">  Standard Split Spoon   Water Table ATD                 </div> <div style="text-align: center;">  No recovery                 </div> </div>							
SUMMARY OF SUBSURFACE CONDITIONS									

65	21	SP	.....same as above, medium dense	25		
70	22	SP	.....same as above	23		-200=12.6%, SO4
75	42	SP	.....same as above, grayish to yellowish brown, medium dense to dense	22		
75	39	SP	Clayey Sand- grayish brown, fine to medium, dense, wet	27		-200=38.5%
Bottom of Boring at 76.5 feet No caving observed No static groundwater encountered Boring backfilled with bentonite slurry						

LOG OF BORING: 20-7176 XEBEC FIGUEROA.GPJ\_TGR GEOTECH.GDT 2/16/21

This Boring Log should be evaluated in conjunction with the complete geotechnical report. This Boring Log represents conditions observed at the specific location and date indicated, it is not warranted to be representative of subsurface conditions at other locations and times.

PLATE 16



**COLEMAN GEOTECHNICAL SUBSURFACE LOG**

<b>CLIENT:</b> Carson Valley, LLC	<b>JOB NO:</b> 2336	<b>DATE:</b> 4/14/2004
<b>Boring Location NO.</b> B-1	<small>EQUIPMENT:</small> <input checked="" type="checkbox"/> HOLLOW STEM <input type="checkbox"/> BACKHOE <input type="checkbox"/> HAND PIT <input type="checkbox"/> BUCKET AUGER	<b>DIAMETER:</b> 8"
<b>ADDRESS:</b> E. of Figueroa St., approx., 350 feet N. of Torrance Blvd., Carson, CA		<b>LOGGED BY:</b> LAS

**Boring Location:**  
N 33.84411  
W 118.28379

LABORATORY DATA				DEPTH (feet)	FIELD DATA			UNIFIED SOIL CLASSIFICATION	SOIL/BEDROCK DESCRIPTION
DRY DENSITY (pcf)	MAX. DENSITY (pcf)	RELATIVE COMPACTION%	MOISTURE CONTENT (%)		BULK SAMPLE	DRIVE SAMPLE	"N" VALUE		
				0'				Af LANDFILL: Mixed TRASH and SOIL, Most trash is wood, Wood pulp, paper, timber, lesser metal and plastic, dark Greenish gray in overall color – Description based on material brought to the surface by the Hollow-stem augers – NO SAMPLES OBTAINED	
				5'					
				20'					
				35'	S	21			
			24.9	40'				ALLUVIUM: Clayey SILT, grayish green, moist, very stiff  - Sandy SILT, olive gray and greenish gray, moist, stiff, trace of Clay  - Sandy SILT and SILT, light greenish gray, moist, stiff  - Clayey SILT and SILT, light brown, moist to very moist, stiff	
110			20.1	45'	R				
			28.3	50'	S	10			
94			28.1	55'	R				
				60'				Bottom of Boring @ 51.0 Feet Lower 25.0' of Hole Backfilled with Bentonite No Groundwater Noted	

This log is a representation of conditions at the time and place of excavation. With the passage of time and at other locations, conditions may vary. DRIVE SAMPLER: S = Standard Penetration Test, R = Ring Sampler, M = Moisture  
 SHEET   1   OF   1   APPENDIX PAGE   C

**COLEMAN GEOTECHNICAL SUBSURFACE LOG**

<b>CLIENT:</b> Carson Valley, LLC	<b>JOB NO:</b> 2336	<b>DATE:</b> 4/14/2004
<b>Boring Location NO.</b> B-2	EQUIPMENT: <input checked="" type="checkbox"/> HOLLOW STEM <input type="checkbox"/> BACKHOE <input type="checkbox"/> HAND PIT <input type="checkbox"/> BUCKET AUGER	<b>DIAMETER:</b> 8"
<b>ADDRESS:</b> E. of Figueroa St., approx., 350 feet N. of Torrance Blvd., Carson, CA		<b>LOGGED BY:</b> LAS

**Boring Location:**  
N 33.84338  
W 118.28375

LABORATORY DATA				DEPTH (feet)	FIELD DATA			UNIFIED SOIL CLASSIFICATION	SOIL/BEDROCK DESCRIPTION
DRY DENSITY (pcf)	MAX. DENSITY (pcf)	RELATIVE COMPACTION%	MOISTURE CONTENT (%)		BULK SAMPLE	DRIVE SAMPLE	"N" VALUE		
				0'				LANDFILL: Mixed TRASH, SOIL, and Concrete Rubble; Dark gray overall Description based on material brought to the surface by the Hollow-stem augers – NO SAMPLES OBTAINED	
				5'					
				20'					
				35'				ALLUVIUM: Clayey SILT, greenish gray, moist stiff  - Sandy SILT, trace of clay, light brown and greenish gray, moist, stiff  - Sandy SILT, SILT, and Clayey SILT, light gray and light brown, moist to very moist, stiff  - Sandy SILT, Clayey SILT, and Silty CLAY, moist, stiff, mottled  Bottom of Boring @ 51.0 Feet Slight Seepage @ 45.0 Feet	
		19.1			S	17			
111			20.4	40'	R				
				45'					
		24.9			S	11			
98			27.1	50'	R				
				55'					
				60'					

This log is a representation of conditions at the time and place of excavation. With the passage of time and at other locations, conditions may vary. DRIVE SAMPLER: S = Standard Penetration Test, R = Ring Sampler, M = Moisture  
 SHEET   1   OF   1   APPENDIX PAGE   D

**COLEMAN GEOTECHNICAL SUBSURFACE LOG**

<b>CLIENT:</b> Carson Valley, LLC	<b>JOB NO:</b> 2336	<b>DATE:</b> 4/14/2004
<b>Boring Location NO.</b> B-3	EQUIPMENT: <input checked="" type="checkbox"/> HOLLOW STEM <input type="checkbox"/> BACKHOE <input type="checkbox"/> HAND PIT <input type="checkbox"/> BUCKET AUGER	<b>DIAMETER:</b> 8"
<b>ADDRESS:</b> E. of Figueroa St., approx., 350 feet N. of Torrance Blvd., Carson, CA		<b>LOGGED BY:</b> LAS

**Boring Location:**  
 N 33.84382  
 W 118.28251

LABORATORY DATA				DEPTH (feet)	FIELD DATA			UNIFIED SOIL CLASSIFICATION	SOIL/BEDROCK DESCRIPTION
DRY DENSITY (pcf)	MAX. DENSITY (pcf)	RELATIVE COMPACTION%	MOISTURE CONTENT (%)		BULK SAMPLE	DRIVE SAMPLE	"N" VALUE		
				0'				Af	LANDFILL: Mixed TRASH and SOIL, Most trash is wood, Wood pulp, paper, timber, lesser metal and plastic, dark gray in overall color Description based on material brought to the surface by the Hollow-stem augers – NO SAMPLES OBTAINED
				5'					
				20'					
				35'					
				40'	S	16		ALLUVIUM:  - Clayey SILT, light brown, moist, stiff, minor very fine sand  - Sandy SILT and SILT, light brown , damp to moist, stiff to Very stiff  - Very Fine SAND, dark gray, moist, dense, minor olive gray silty clay blebs and lens  - Clayey SILT, trace of sand, gray brown, moist, firm to stiff	
				45'					
				50'	S	39			
				55'	R				
				60'	S	8			
								Bottom of Boring @ 51.0 Feet Lower 25.0' of Hole Backfilled with Bentonite Slight Seepage At Base of LANDFILL(30-35')	

This log is a representation of conditions at the time and place of excavation. With the passage of time and at other locations, conditions may vary. DRIVE SAMPLER: S = Standard Penetration Test, R = Ring Sampler, M = Moisture  
 SHEET   1   OF   1   APPENDIX PAGE   E

**COLEMAN GEOTECHNICAL SUBSURFACE LOG**

<b>CLIENT:</b> Carson Valley, LLC	<b>JOB NO:</b> 2336	<b>DATE:</b> 4/14/2004
<b>Boring Location NO.</b> B-4	<small>EQUIPMENT:</small> <input checked="" type="checkbox"/> HOLLOW STEM <input type="checkbox"/> BACKHOE <input type="checkbox"/> HAND PIT <input type="checkbox"/> BUCKET AUGER	<b>DIAMETER:</b> 8"
<b>ADDRESS:</b> E. of Figueroa St., approx., 350 feet N. of Torrance Blvd., Carson, CA		<b>LOGGED BY:</b> LAS

**Boring Location:**  
N 33.84428  
W 118.28061

LABORATORY DATA				DEPTH (feet)	FIELD DATA			UNIFIED SOIL CLASSIFICATION	SOIL/BEDROCK DESCRIPTION
DRY DENSITY (pcf)	MAX. DENSITY (pcf)	RELATIVE COMPACTION%	MOISTURE CONTENT (%)		BULK SAMPLE	DRIVE SAMPLE	"N" VALUE		
				0'				Af	LANDFILL: MIXED SILT, CLAY, and TRASH, very dark gray  Description based on material brought to the surface by the Hollow-stem augers – NO SAMPLES OBTAINED
				5'					
				20'					
79			43.6	35'		R		V ≈≈≈	ALLUVIUM: Silty CLAY, greenish gray and gray, moist to very Moist, soft to firm, high plasticity  - Clayey SILT, dark gray brown and light green gray, moist, Firm to stiff, some caliche (veinlets), Seepage at 43.0'  - Silty Fine SAND, light greenish gray, very moist to wet, dense  - Sandy CLAY, Sandy SILT, Silty Fine SAND, wet, firm to stiff
				40'		S 9			
104			23.3	45'		R			
				50'		S 13			
			23.0	55'					Bottom of Boring @ 50.0 Feet Lower 25.0' of Hole Backfilled with Bentonite Slight Seepage @ 43.0'
				60'					

This log is a representation of conditions at the time and place of excavation. With the passage of time and at other locations, conditions may vary. DRIVE SAMPLER: S = Standard Penetration Test, R = Ring Sampler, M = Moisture  
 SHEET   1   OF   1   APPENDIX PAGE   F

### COLEMAN GEOTECHNICAL SUBSURFACE LOG

<b>CLIENT:</b> Carson Valley, LLC	<b>JOB NO:</b> 2336	<b>DATE:</b> 4/14/2004
<b>Boring Location NO.</b> B-5	<small>EQUIPMENT:</small> <input checked="" type="checkbox"/> HOLLOW STEM <input type="checkbox"/> BACKHOE <input type="checkbox"/> HAND PIT <input type="checkbox"/> BUCKET AUGER	<b>DIAMETER:</b> 8"
<b>ADDRESS:</b> E. of Figueroa St., approx., 350 feet N. of Torrance Blvd., Carson, CA		<b>LOGGED BY:</b> LAS

**Boring Location:**  
N 33.84347  
W 118.28054

LABORATORY DATA				DEPTH (feet)	FIELD DATA			UNIFIED SOIL CLASSIFICATION	SOIL/BEDROCK DESCRIPTION
DRY DENSITY (pcf)	MAX. DENSITY (pcf)	RELATIVE COMPACTION%	MOISTURE CONTENT (%)		BULK SAMPLE	DRIVE SAMPLE	"N" VALUE		
				0'				Af	LANDFILL: MIXED SILT, CLAY, and TRASH, very dark gray
				5'					Description based on material brought to the surface by the Hollow-stem augers – NO SAMPLES OBTAINED
				20'					
				35'		S	20		- trash in sample
				40'		R			ALLUVIUM: Silty CLAY, greenish gray and gray, moist to very
111			18.9	45'		S	16		Moist, soft to firm, high plasticity
			24.9	50'		R			- Sandy SILT and SILT, trace of clay, light greenish gray, very moist, stiff
				55'		S	22		- Interbedded SILT, Sandy SILT, and Clayey SILT, moist stiff, greenish gray and gray overall
98			28.2	60'					- SILT and Clayey SILT, light brown, very moist to wet, firm to Stiff
			26.2						- Silty CLAY, Clayey SILT, SILT, greenish gray and dark gray
									Bottom @ 55.0 Feet Seepage between 40-45' Lower 30' of Hole Backfilled with Bentonite Slurry

This log is a representation of conditions at the time and place of excavation. With the passage of time and at other locations, conditions may vary. DRIVE SAMPLER: S = Standard Penetration Test, R = Ring Sampler, M = Moisture

**APPENDIX C  
LABORATORY TEST RESULTS  
(TGR AND COLEMAN GEOTECHNICAL)**



## APPENDIX C

### Laboratory Testing Procedures and Results

**Moisture and Density Determination Tests:** Moisture content and dry density determinations were performed on relatively undisturbed samples obtained from the test borings. The results of these tests are presented in the boring logs. Where applicable, only moisture content was determined from "undisturbed" or disturbed samples.

**Direct Shear Tests:** Direct shear test was performed on selected remolded and/or undisturbed sample, which was soaked for a minimum of 24 hours under a surcharge equal to the applied normal force during testing. After transfer of the sample to the shear box, and reloading the sample, pore pressures set up in the sample due to the transfer were allowed to dissipate for a period of approximately 1-hour prior to application of shearing force. The sample was tested under various normal loads, a motor-driven, strain-controlled, direct-shear testing apparatus at a strain rate of less than 0.001 to 0.5 inches per minute (depending upon the soil type). The test result is presented in the test data and in the table below:

Sample Location	Sample Description	Friction Angle (degrees)	Apparent Cohesion (psf)
B-5 @ 35 feet	Silty Sand- Saturated, Peak	21	588
	Silty Sand- Saturated, Ultimate	24	336
B-5 @ 45 feet	Sandy Clay- Saturated, Peak	20	774
	Sandy Clay- Saturated, Ultimate	23	474

**Soluble Sulfates:** The soluble sulfate content of selected sample was determined by standard geochemical methods. The test result is presented in the table below:

Sample Location	Sample Description	Water Soluble Sulfate in Soil, (% by Weight)	Sulfate Content (ppm)	Exposure Class*
B-5 @ 55 feet	Sand	0.1975	1975	S1
B-5 @ 65 feet	Sand	0.2794	2794	S2

\* Based on the current version of ACI 318-14 Building Code, Table No. 19.3.1.1; Exposure Categories and Classes.

Corrosivity Tests: Electrical conductivity, pH, and soluble chloride tests were performed by Coleman, 2004, on representative samples and the results are provided below:

Sample Location	Soluble Chloride (CAL.422) ppm	Electrical Resistivity (CAL.643) (ohm-cm)	PH (CAL.747)	Potential Degree of Attack on Steel
B-2 (2006) @ 35-36 feet	547	<600	7.0	Severe
B-2 (2006) @ 45-46 feet	507	964	7.3	Severe

Wash Sieve Test: Typical materials were washed over No. 200 sieve (ASTM Test Method D1140). The test results are presented below:

Sample Location	% Passing No. 200 Sieve
B-1 @ 55 feet	57.3%
B-1 @ 65 feet	36.0%
B-1 @ 70 feet	78.5%
B-1 @ 75 feet	87.0%
B-2 @ 65 feet	55.6%
B-2 @ 70 feet	51.2%
B-2 @ 75 feet	22.0%
B-3 @ 60 feet	67.4%
B-3 @ 70 feet	78.4%
B-3 @ 75 feet	77.9%
B-4 @ 50 feet	81.9%
B-4 @ 55 feet	41.6%
B-4 @ 60 feet	76.1%
B-4 @ 65 feet	30.0%
B-5 @ 35 feet	60.8%
B-5 @ 40 feet	61.2%
B-5 @ 50 feet	69.0%
B-5 @ 55 feet	11.3%

B-5 @ 65 feet	12.6%
B-5 @ 75 feet	38.5%

Atterberg Limits: The Atterberg Limits were determined in accordance with ASTM Test Method D4318 for engineering classification of the fine-grained materials and presented in the table below:

Sample Location	Liquid Limit (%)	Plastic Limit (%)	Plasticity Index (%)
B-5 @35	34	16.2	17.8
B-5 @40	32	7.6	24.4
B-5 @50	28	23	5

SHEAR STRENGTH, psf

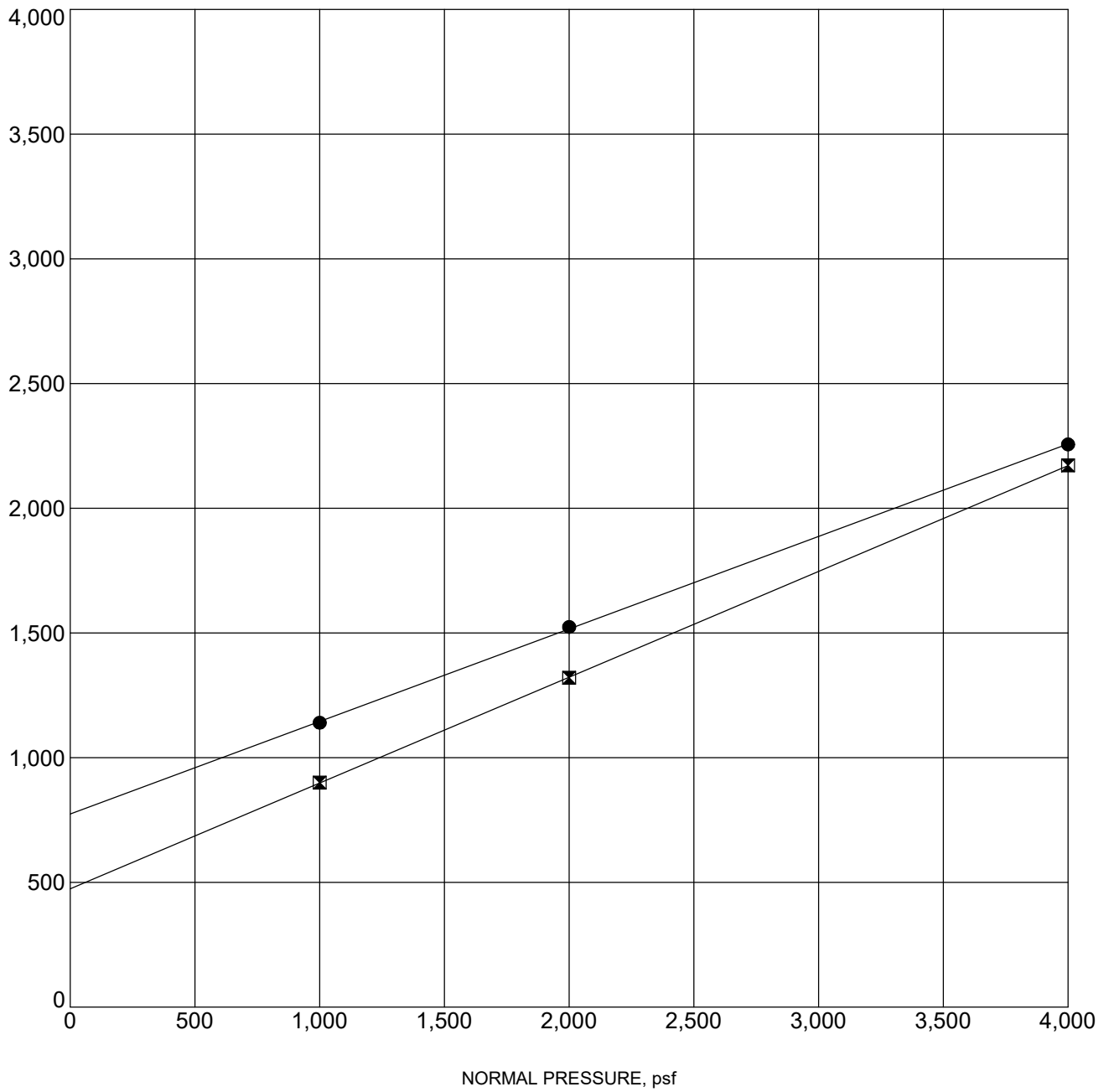

US DIRECT SHEAR 20-7176 XEBEC FIGUEROA.GPJ TGR GEOTECH.GDT 2/3/21

Specimen Identification	Classification	$\gamma_d$	MC%	c	$\phi$
● B-5 45.0	Sandy Clay, Peak	25	104	774	20
⊠ B-5 45.0	Sandy Clay, Ultimate	25	104	474	23



TGR GEOTECHNICAL, INC.

3037 S. Harbor Blvd  
 Santa Ana, CA 92704  
 Telephone: 714-641-7189  
 Fax:

**DIRECT SHEAR TEST**

Project Number: 20-7176

Project Name: Figueroa Street Business Park, Carson

SHEAR STRENGTH, psf

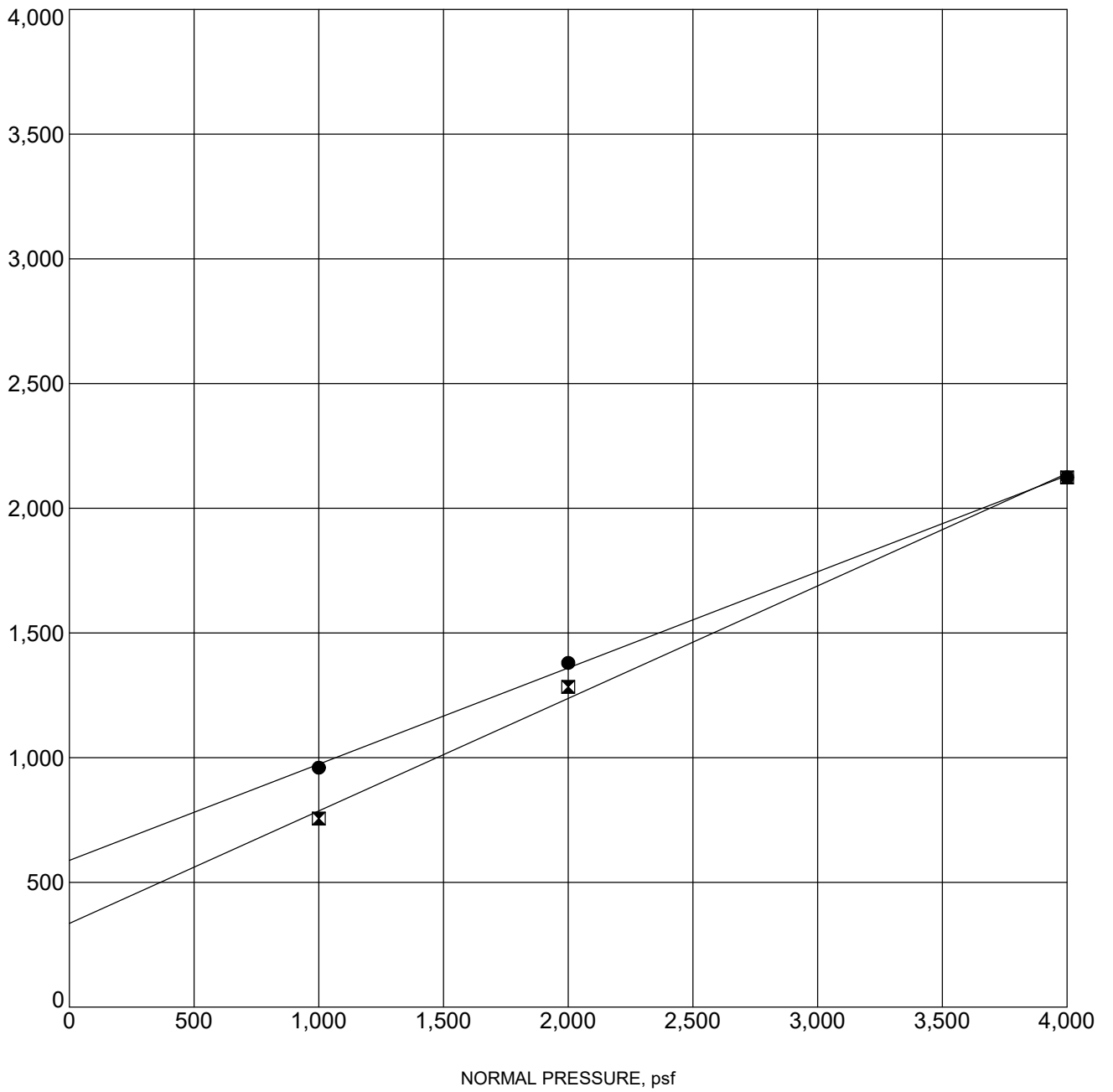

US DIRECT SHEAR 20-7176 XEBEC FIGUEROA.GPJ TGR GEOTECH.GDT 2/3/21

Specimen Identification	Classification	$\gamma_d$	MC%	c	$\phi$
● B-5 35.0	Sandy Clay, Peak	97	28	588	21
☒ B-5 35.0	Sandy Clay, Ultimate	97	28	336	24



TGR GEOTECHNICAL, INC.

3037 S. Harbor Blvd  
 Santa Ana, CA 92704  
 Telephone: 714-641-7189  
 Fax:

**DIRECT SHEAR TEST**

Project Number: 20-7176

Project Name: Figueroa Street Business Park, Carson

# ANAHEIM TEST LAB, INC.

196 Technology Drive, Unit D  
Irvine, CA 92618  
Phone (949) 336-6544

TO:

TGR GEOTECHNICAL  
3037 S. HARBOR BLVD.  
SANTA ANA, CA. 92704

DATE: 1/27/2021

P.O. NO: VERBAL

LAB NO: C-4463, 1-2

SPECIFICATION: CTM-417

MATERIAL: Soil

---

Project No.: 20-7176  
Project: Xebec Figueroa St.

## ANALYTICAL REPORT

### SOLUBLE SULFATES

per CT. 417  
ppm

1) B5 @ 55'	1,975
2) B5 @ 65'	2,794

RESPECTFULLY SUBMITTED



---

WES BRIDGER LAB MANAGER

SHEARING LOAD, P.S.F.

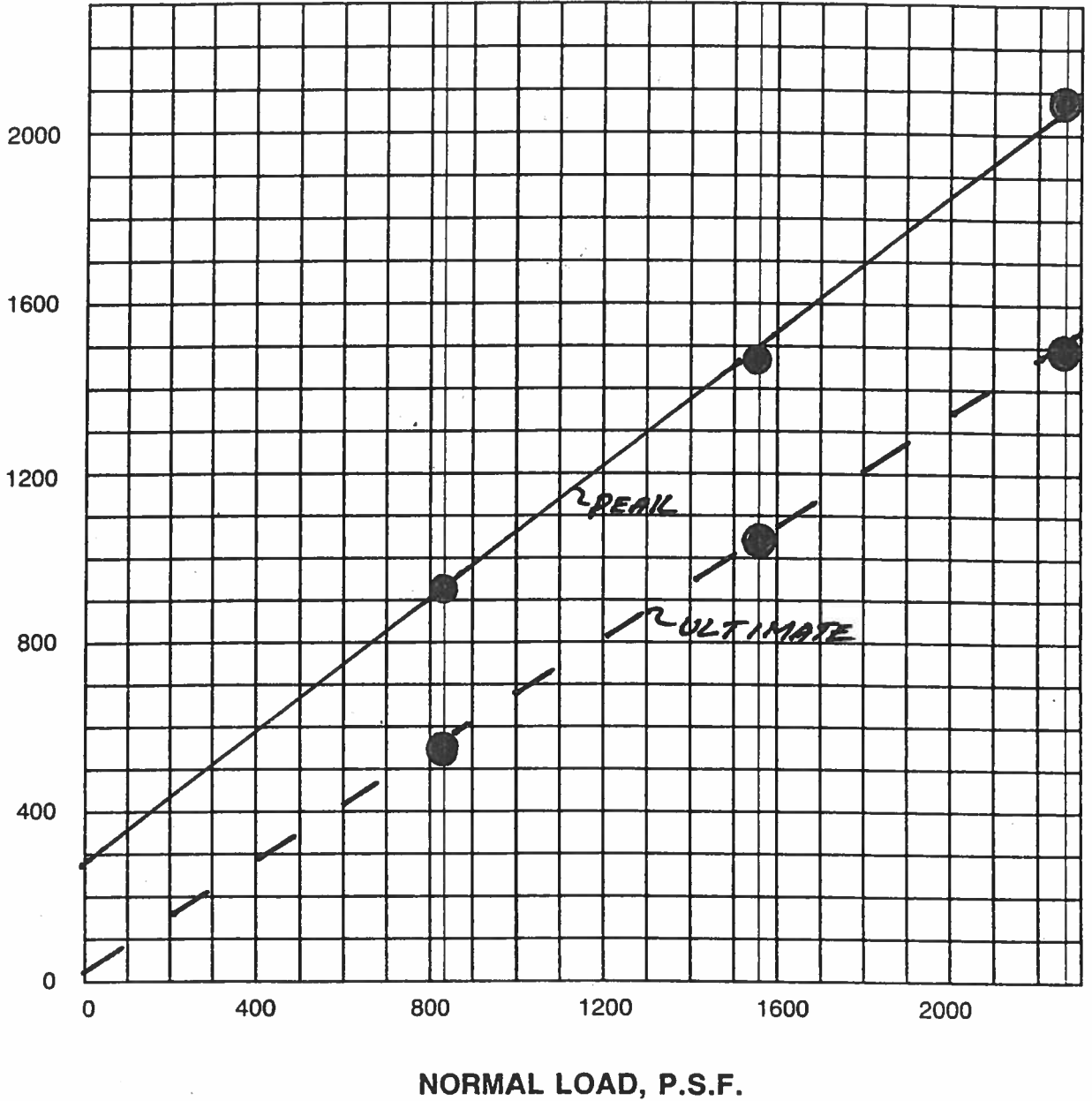

**COLEMAN GEOTECHNICAL**

**SAMPLE INFORMATION**

Boring No. *B-2*  
 Sample Depth: *40.1'*

**TEST INFORMATION**

- Undisturbed      ○ Remolded
- Moisture Content      ■ Saturated      □ Natural
- Remolded Density      □ 90% of Max.      □ Natural

**DIRECT SHEAR  
 SUMMARY**

JOB NO.	DATE	DRAWN BY	APPENDIX PAGE
<i>2336</i>	<i>9/04</i>	<i>NRC</i>	Page H

*L95*

SHEARING LOAD, P.S.F.

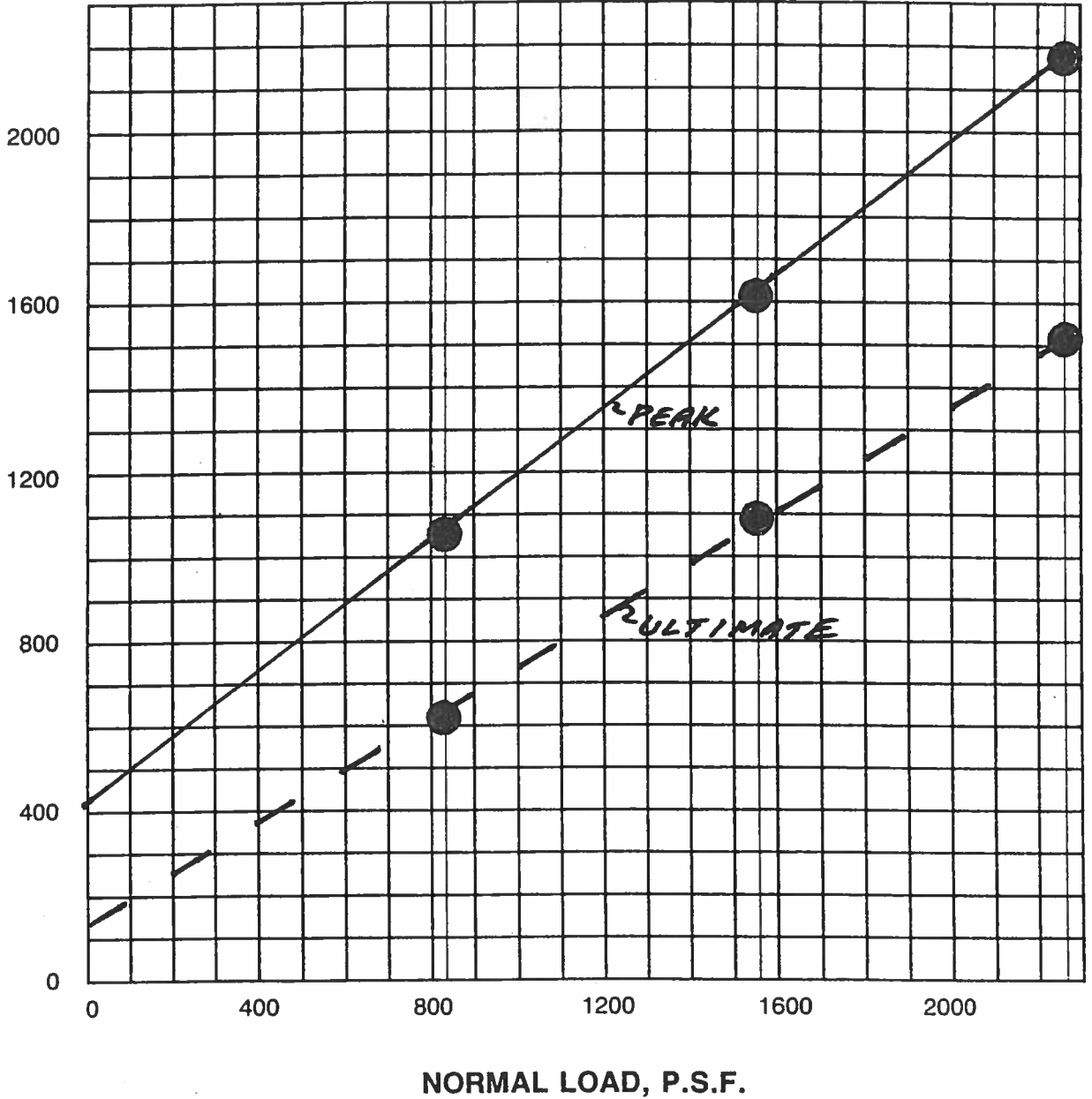

**SAMPLE INFORMATION**

Boring No. *B-2*  
 Sample Depth: *50.0'*

**TEST INFORMATION**

- Undisturbed      ○ Remolded
- Saturated        □ Natural
- 90% of Max.    □ Natural

**COLEMAN GEOTECHNICAL**

**DIRECT SHEAR  
SUMMARY**

JOB NO.	DATE	DRAWN BY	APPENDIX PAGE
<i>2336</i>	<i>4/04</i>	<i>NRC</i>	Page <i>I</i>

*295*



SHEARING LOAD, P.S.F.

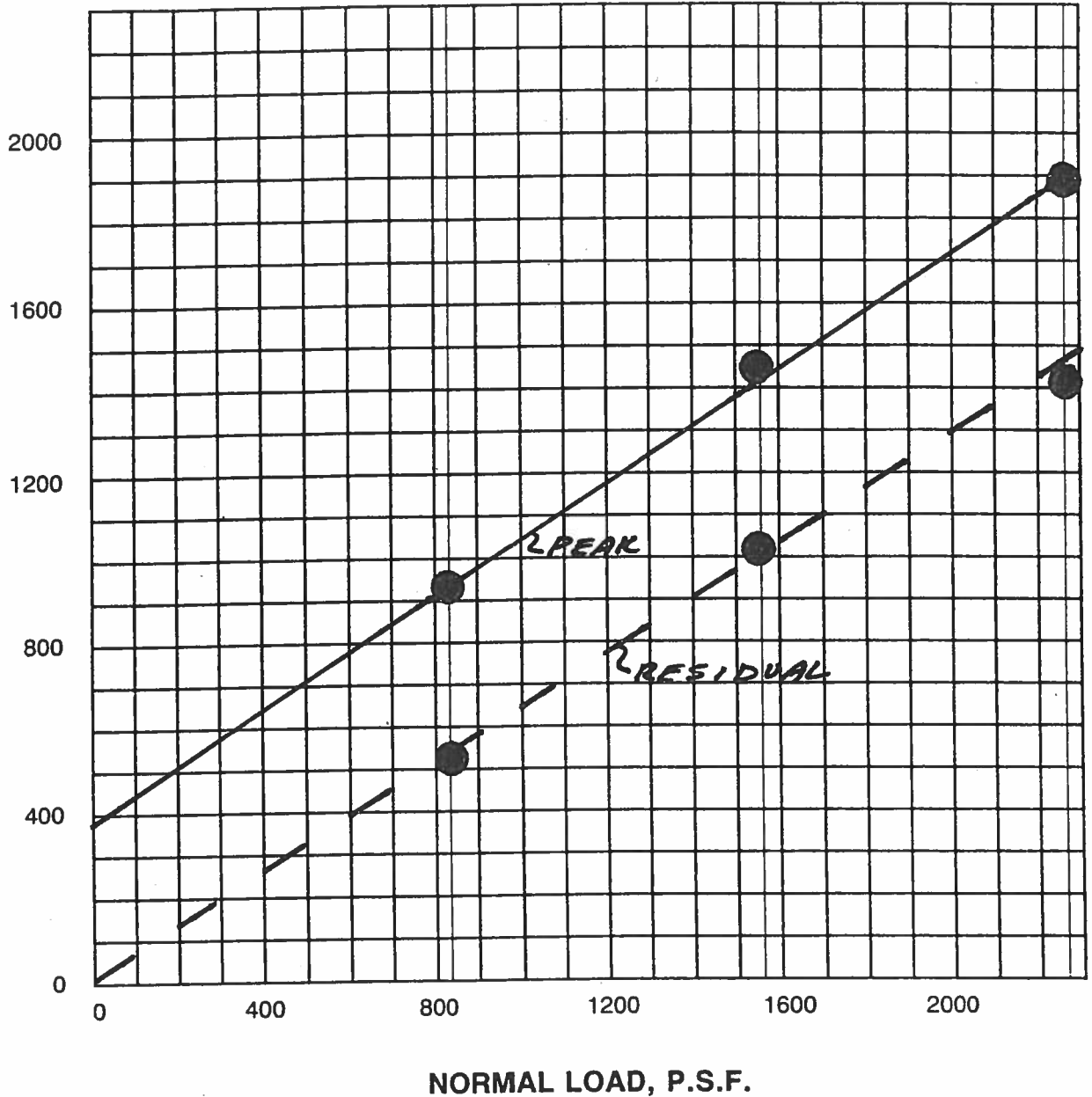

SAMPLE INFORMATION  
 Boring No. *B-4*  
 Sample Depth: *35.0'*

TEST INFORMATION

- Undisturbed
- Remolded
- Moisture Content
- Saturated
- Natural
- Remolded Density
- 90% of Max.
- Natural

COLEMAN GEOTECHNICAL

DIRECT SHEAR  
 SUMMARY

JOB NO.	DATE	DRAWN BY	APPENDIX PAGE
<i>2336</i>	<i>4/04</i>	<i>JRC</i>	Page <i>J</i>

*LGS*

SHEARING LOAD, P.S.F.

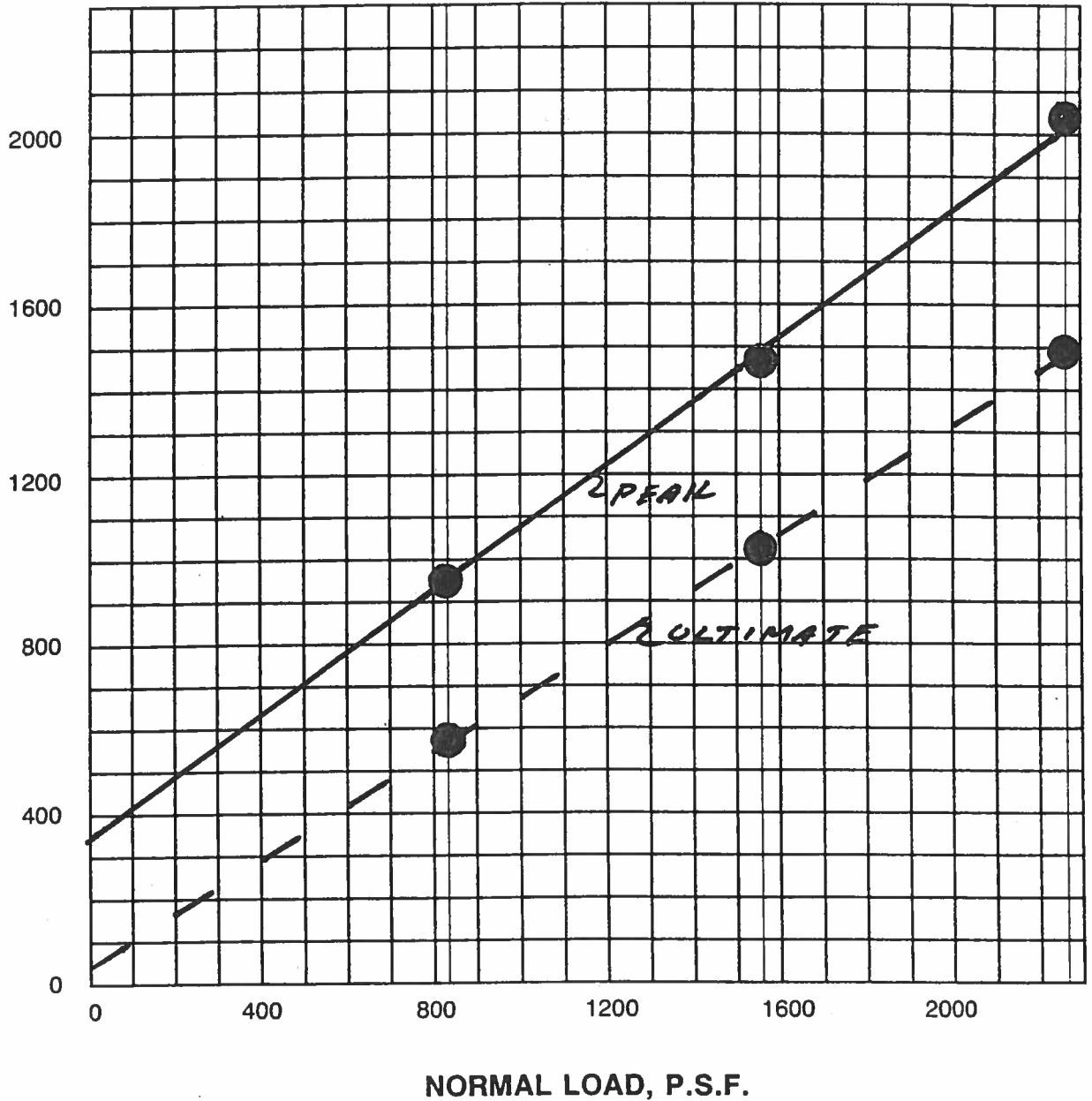

NORMAL LOAD, P.S.F.

**SAMPLE INFORMATION**

Boring No. *B-4*  
 Sample Depth: *45.0'*

**TEST INFORMATION**

- Undisturbed      ○ Remolded
- Moisture Content    ■ Saturated      □ Natural
- Remolded Density   □ 90% of Max.   □ Natural

**COLEMAN GEOTECHNICAL**

**DIRECT SHEAR  
 SUMMARY**

JOB NO.	DATE	DRAWN BY	APPENDIX PAGE
<i>2336</i>	<i>9/04</i>	<i>NRC</i>	Page <i>K</i>

*295*

CONSOLIDATION, percent

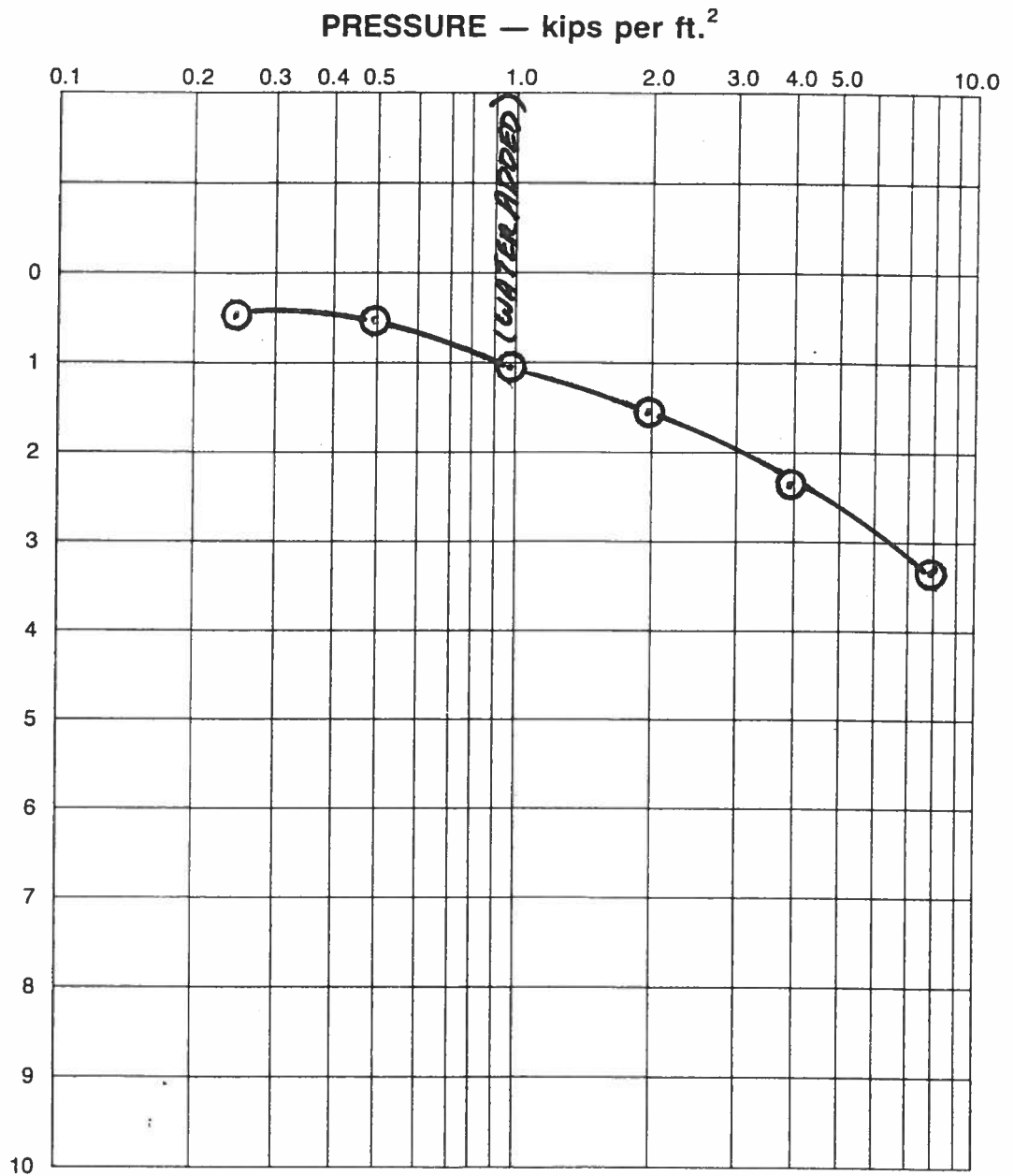

**SAMPLE INFORMATION**

Boring No. *B-5*  
Sample Depth: *40'*

**COLEMAN GEOTECHNICAL**

9272 JERONIMO ROAD, SUITE 104  
IRVINE, CA 92618  
PHONE (949) 461-5260 FAX (949) 461-5262

**PRESSURE -  
CONSOLIDATION**

JOB NO.	DATE	DRAWN BY	APPENDIX
<i>2336</i>	<i>4/04</i>	<i>ARC</i>	Page <i>L</i>

*295*

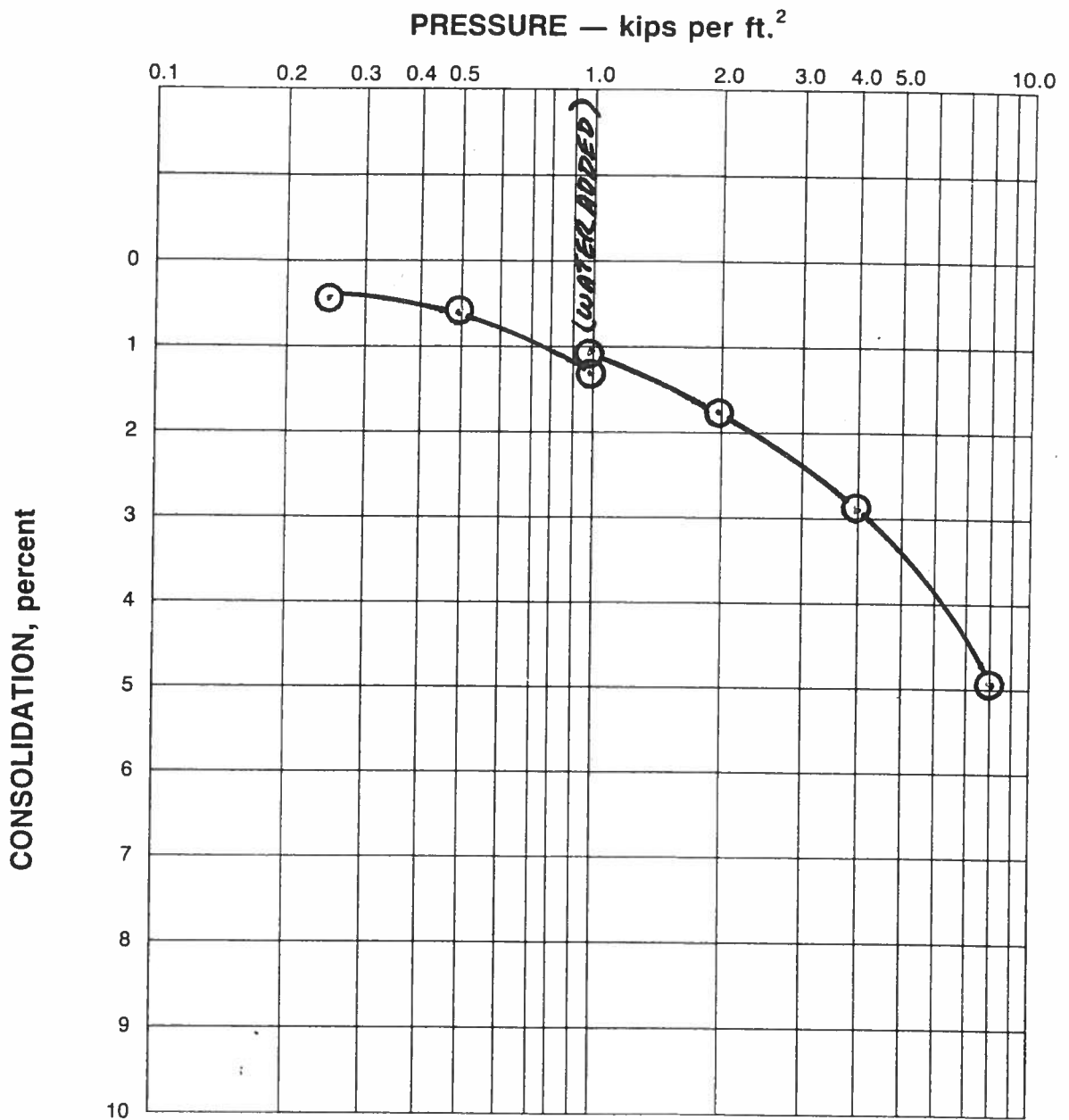

SAMPLE INFORMATION  
 Boring No. *B-5*  
 Sample Depth: *50'*

**COLEMAN GEOTECHNICAL**

9272 JERONIMO ROAD, SUITE 104  
 IRVINE, CA 92618  
 PHONE (949) 461-5260 FAX (949) 461-5262

**PRESSURE -  
 CONSOLIDATION**

JOB NO.	DATE	DRAWN BY	APPENDIX
<i>2336</i>	<i>4/04</i>	<i>JRC</i>	Page <i>M</i>

*L95*

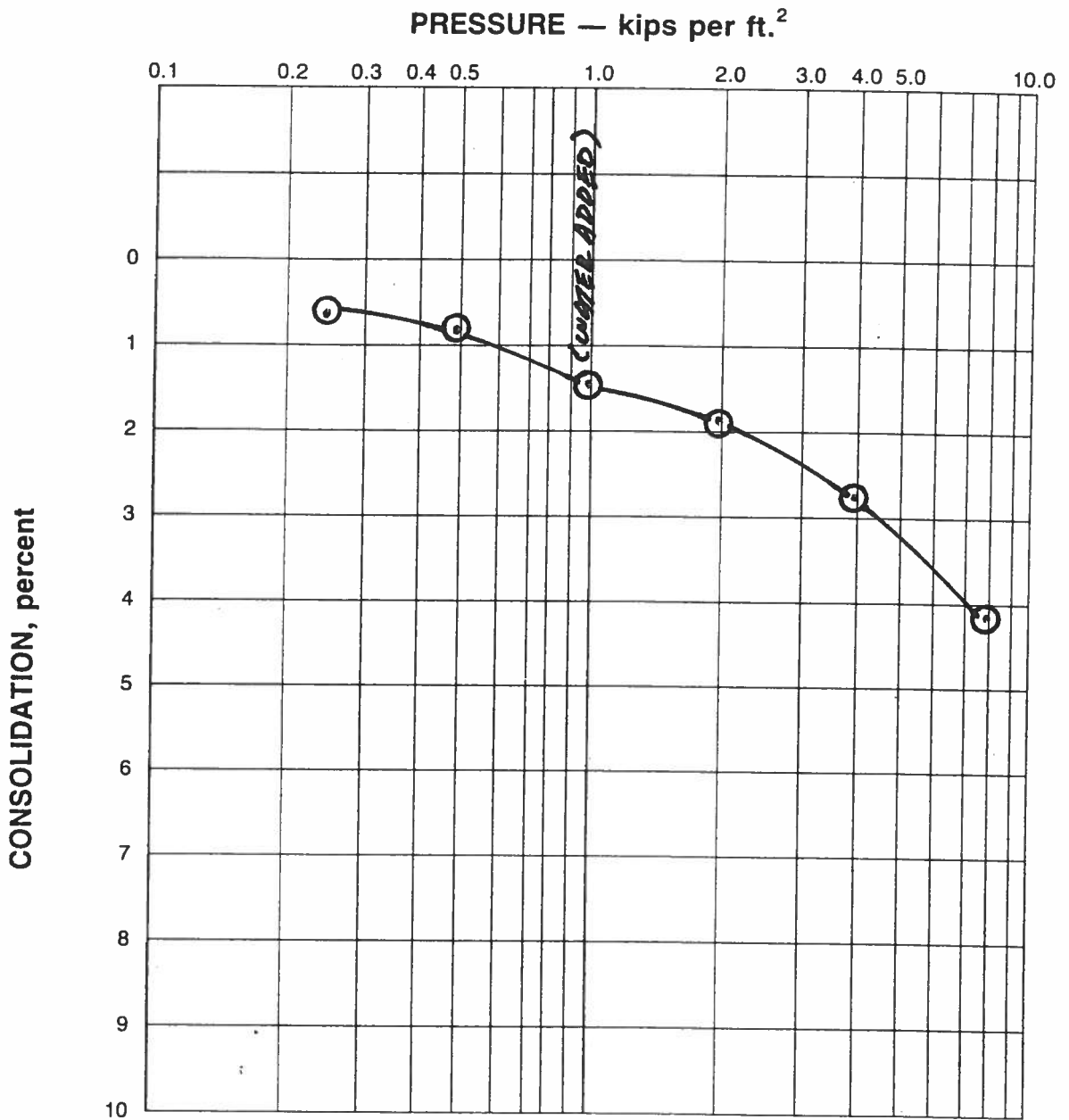

SAMPLE INFORMATION  
 Boring No. *B-1*  
 Sample Depth: *40'*

**COLEMAN GEOTECHNICAL**

9272 JERONIMO ROAD, SUITE 104  
 IRVINE, CA 92618  
 PHONE (949) 461-5260 FAX (949) 461-5262

**PRESSURE -  
 CONSOLIDATION**

JOB NO.	DATE	DRAWN BY	APPENDIX
<i>2336</i>	<i>4/04</i>	<i>ARC</i>	Page N

*LAS*

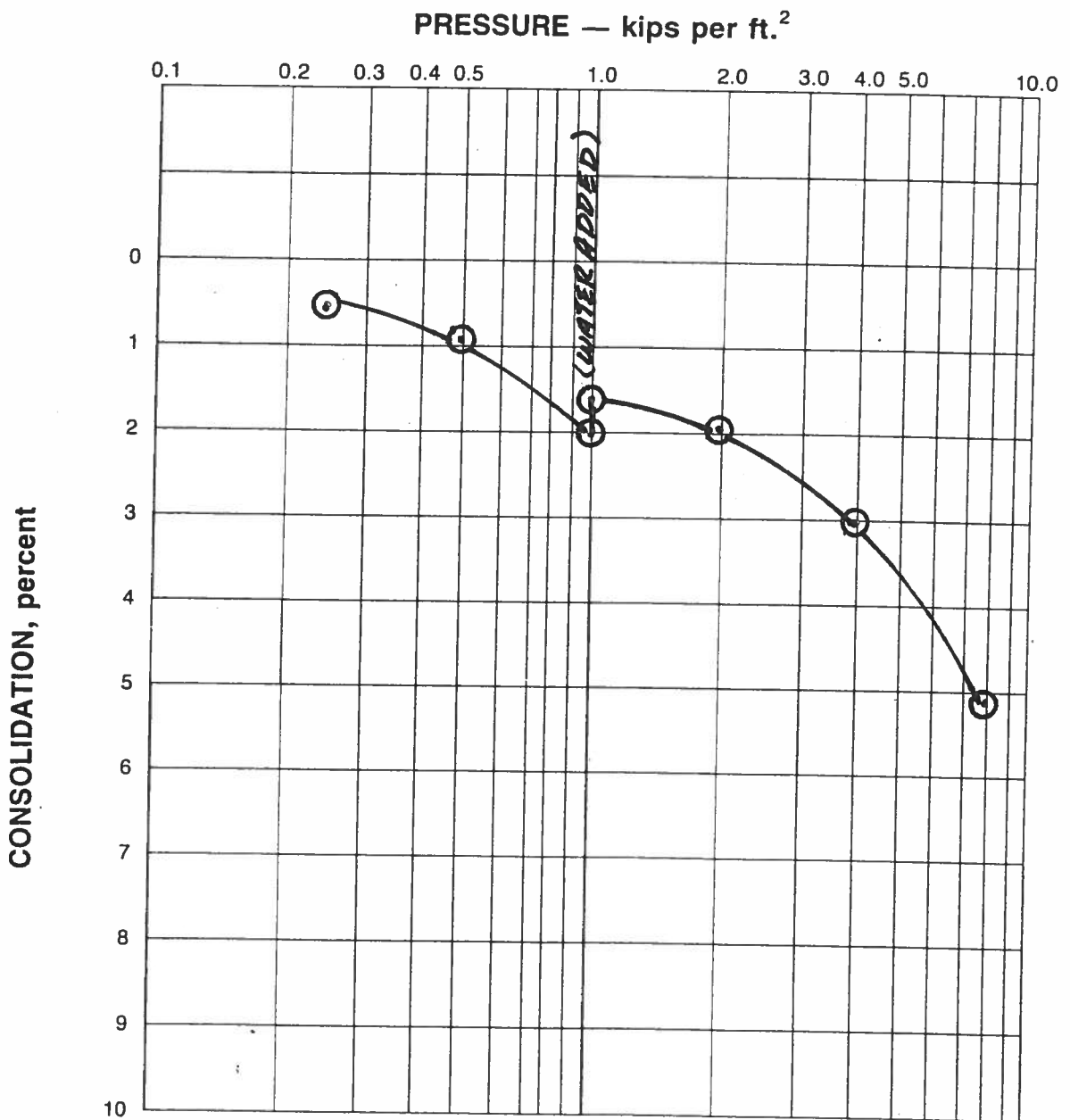

SAMPLE INFORMATION  
 Boring No. *B-1*  
 Sample Depth: *50'*

**COLEMAN GEOTECHNICAL**

9272 JERONIMO ROAD, SUITE 104  
 IRVINE, CA 92618  
 PHONE (949) 461-5260 FAX (949) 461-5262

**PRESSURE -  
 CONSOLIDATION**

JOB NO.	DATE	DRAWN BY	APPENDIX
<i>2336</i>	<i>4/04</i>	<i>JRC</i>	Page <i>0</i>

*295*

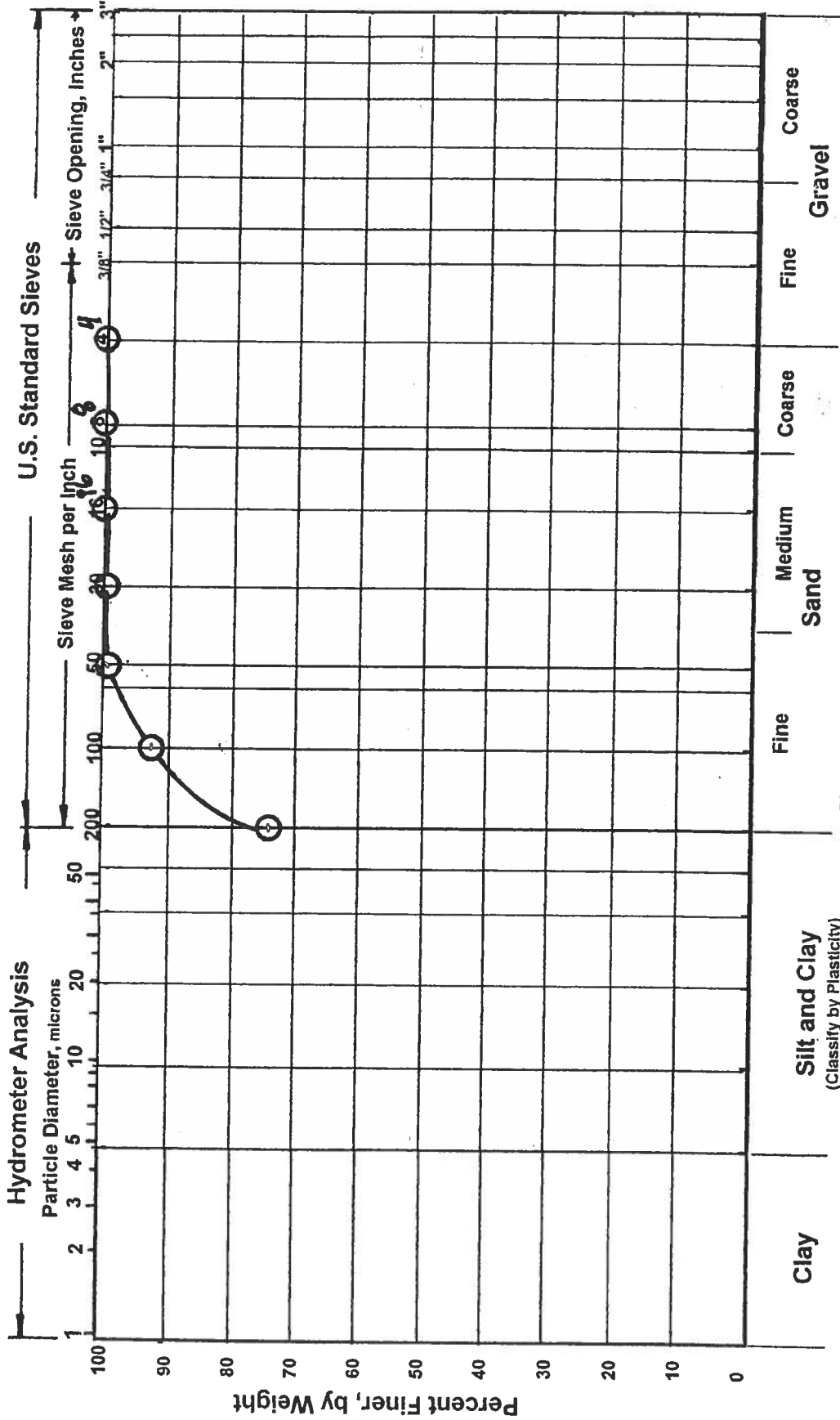

**Sample Information:**

Symbol Boring Depth Plastic Limit Plasticity Index

○ B-1 45'

□

△

---

**COLEMAN GEOTECHNICAL**

---

**GRADATION TESTS**

---

JOB NUMBER	DATE	DRAWN BY	APPENDIX PAGE
2336	4/04	JRC	P

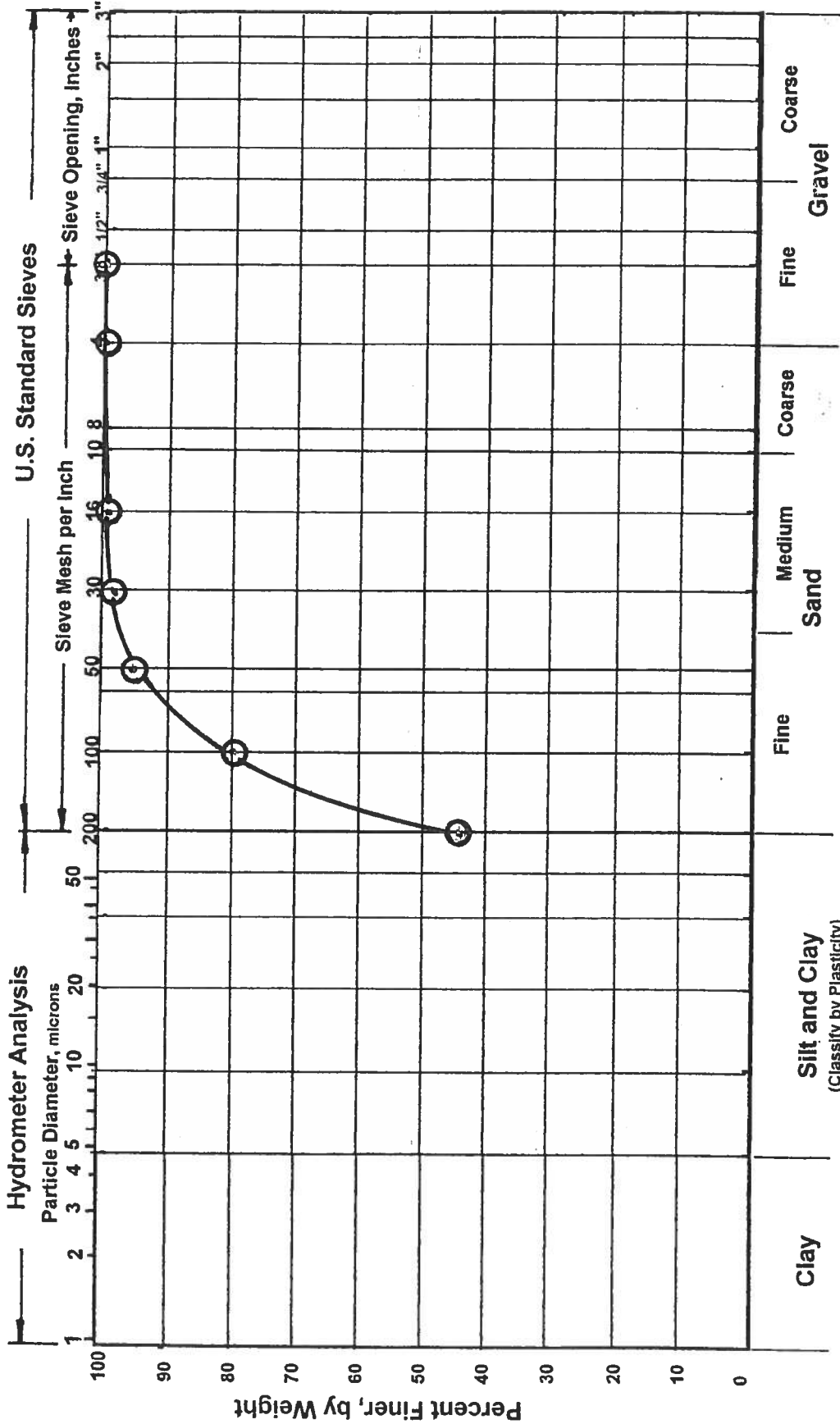

Material Classification

**COLEMAN GEOTECHNICAL**

**GRADATION TESTS**

JOB NUMBER	DATE	DRAWN BY	APPENDIX PAGE
2336	7/04	ARC	Q

Sample Information:

Symbol Boring Depth Liquid Limit Plastic Limit Plasticity Index

○ B-3 40'

□

△



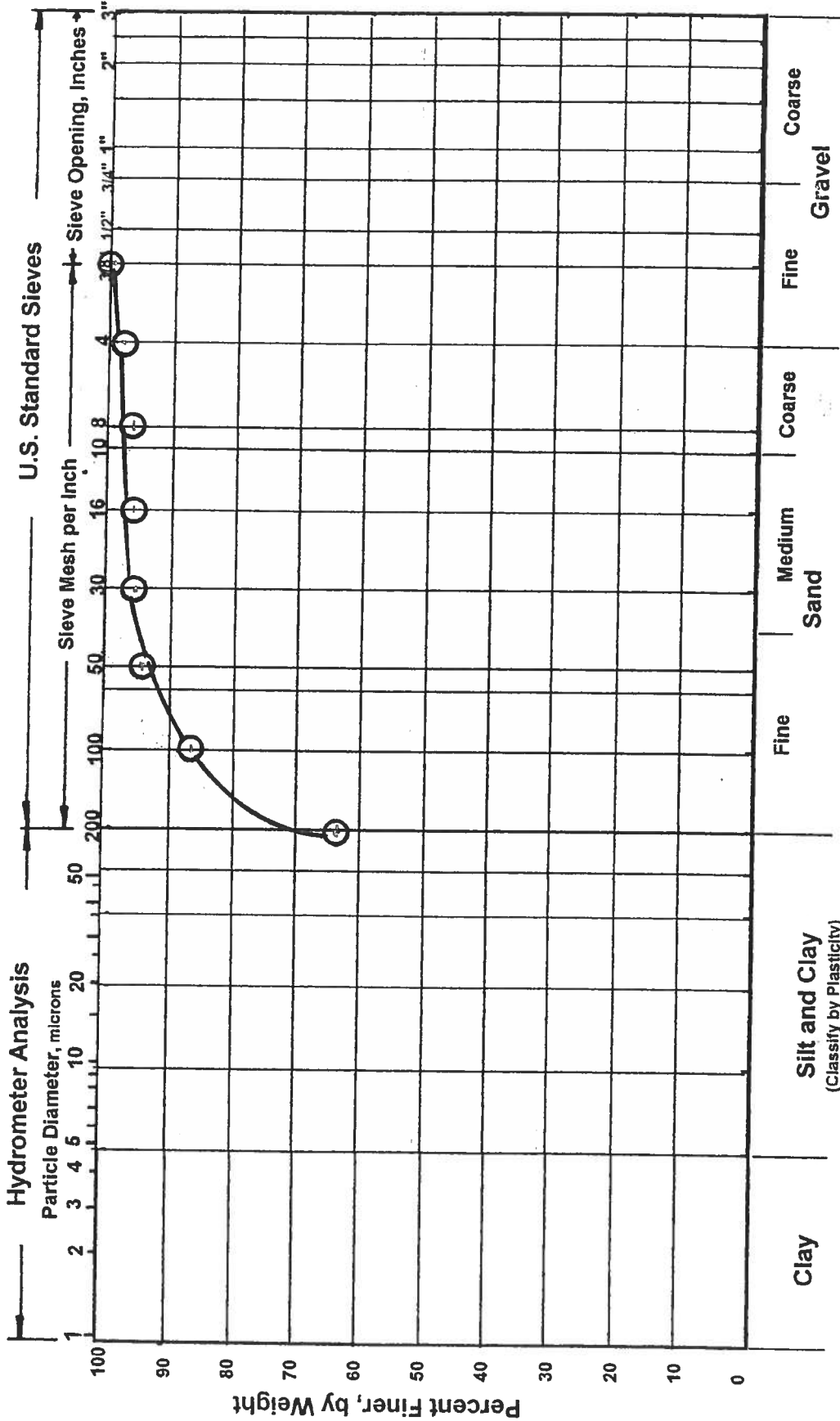

**APPENDIX D**  
**SITE SEISMIC DESIGN AND DE-AGGREGATED PARAMETERS**

**TABLE 1**  
**SITE SPECIFIC GROUND MOTION ANALYSIS**

Figueroa Street Business Park, Carson, CA

SA Period (sec)	Probabilistic Spectral Acceleration (g)	Risk Coefficients	Probabilistic Spectral Acceleration MCER (g)	Deterministic Spectral Acceleration (g)	Is Largest Deterministic Spectral Acceleration <1.5*Fa	Deterministic MCER	Site Specific MCER	2/3 of Spite Specific MCER	80% Code Design	Site Specific Design Response Spectrum
	Rotated Maximum		Rotated Maximum	Rotated Maximum 84th Percentile						
0	0.8140	0.901	0.7334	0.6851	No	0.6851	0.6851	0.4567	0.3682	0.4567
0.1	1.3948	0.901	1.2567	1.0509		1.0509	1.0509	0.7006	0.6757	0.7006
0.2	1.8623	0.901	1.6779	1.4506		1.4506	1.4506	0.9671	0.9205	0.9671
0.3	2.0993	0.901	1.8904	1.7231		1.7231	1.7231	1.1487	0.9205	1.1487
0.5	2.0680	0.900	1.8602	1.8395		1.8395	1.8395	1.2264	0.9205	1.2264
0.75	1.7523	0.898	1.5740	1.6237		1.6237	1.5740	1.0493	0.9205	1.0493
1	1.5210	0.897	1.3643	1.4572		1.4572	1.3643	0.9096	0.8267	0.9096
2	0.8357	0.897	0.7496	0.8636		0.8636	0.7496	0.4997	0.4133	0.4997
3	0.5488	0.897	0.4923	0.5965		0.5965	0.4547	0.3031	0.2756	0.3031
4	0.3872	0.897	0.3473	0.4341		0.4341	0.3410	0.2273	0.2067	0.2273
5	0.2940	0.897	0.2637	0.3284		0.3284	0.2728	0.1819	0.1653	0.1819

Code Sds	1.151	Crs =	0.901	Code Ss =	1.726	<b>Site Specific SDS = 1.104</b>
Code Sd1	1.033	Cr1 =	0.897	Code S1 =	0.62	<b>Site Specific SD1 = 0.999</b>
To	0.18	Code Fa =	1	Sms =	1.726	
Ts	0.90	Code Fv =	2.5	Sm1 =	1.55	
TL	8					
Input						

**FIGURE 1**  
**Site Specific Design Response Spectra**  
**Figueroa Street Business Park, Carson, CA**

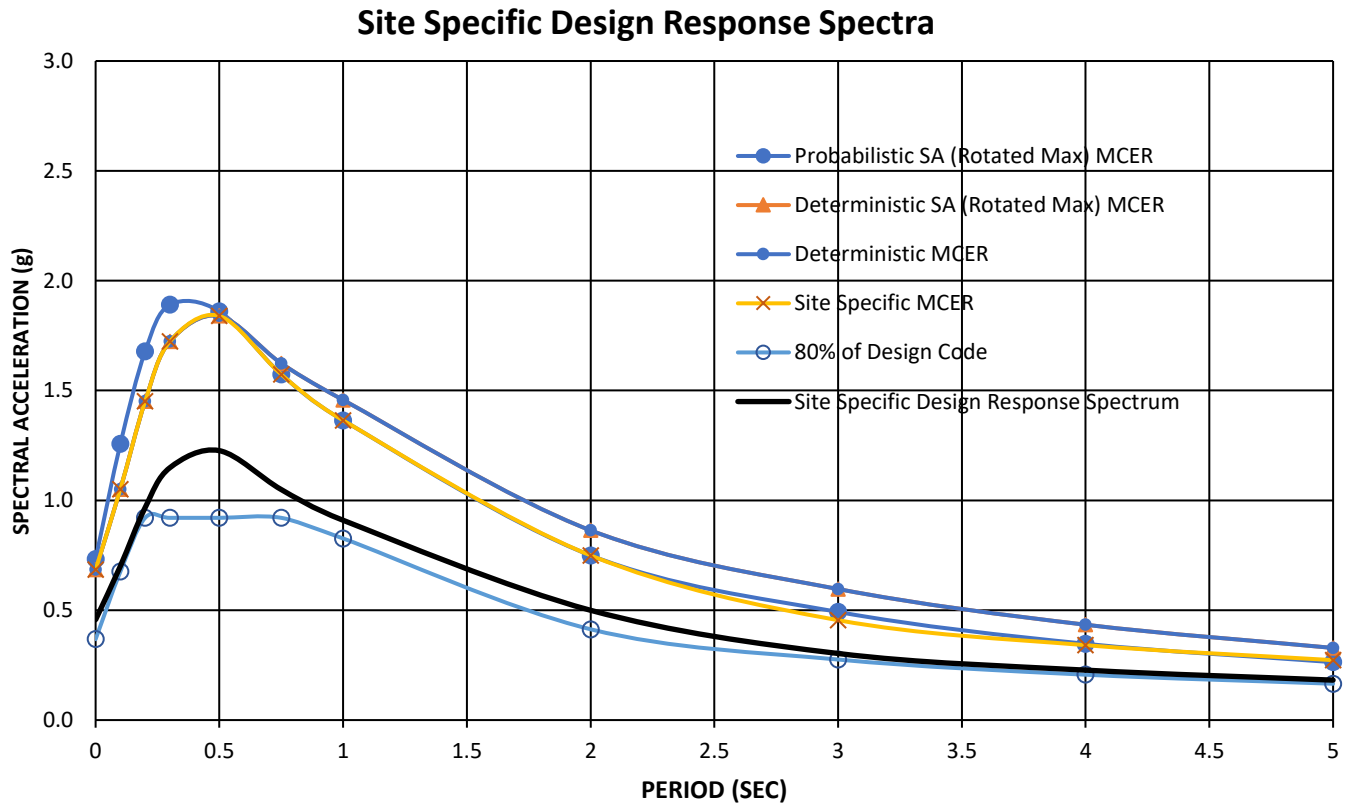
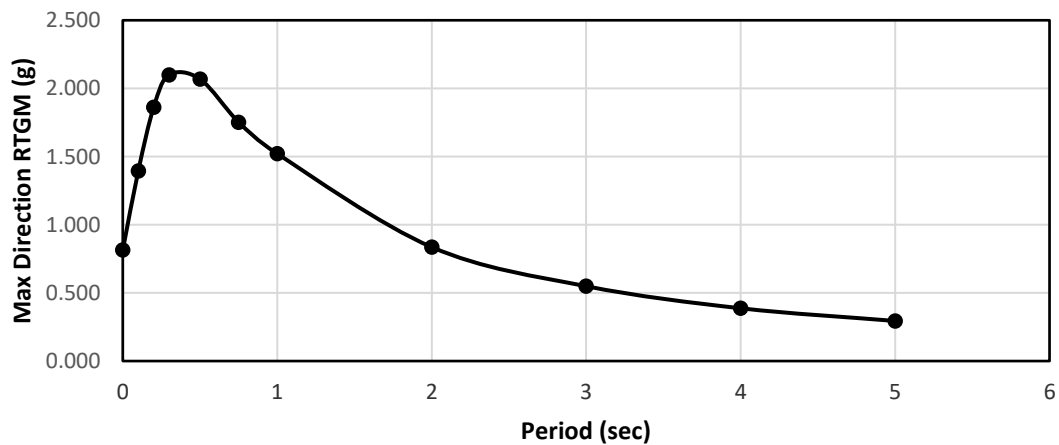

**TABLE 2**

**Probabilistic Response Spectrum ASCE 7-16 Method 2  
Figueroa Street Business Park, Carson, CA**

Period (g)	UHGM (g)	RTGM (g)	Max Dir Scale factor	Max Dir RTGM (g)
0	0.778	0.740	1.1	0.814
0.1	1.310	1.268	1.1	1.395
0.2	1.739	1.693	1.1	1.862
0.3	1.967	1.866	1.125	2.099
0.5	1.901	1.760	1.175	2.068
0.75	1.554	1.416	1.2375	1.752
1	1.291	1.170	1.3	1.521
2	0.690	0.619	1.35	0.836
3	0.439	0.392	1.4	0.549
4	0.299	0.267	1.45	0.387
5	0.219	0.196	1.5	0.294

**Probabilistic Response Spectra per ASCE 7-16**



**TABLE 3**  
**Deterministic Response Spectrum ASCE 7-16**  
**Figuroa Street Business Park, Carson, CA**

Period (g)	Mean Spectra (g)	Sigma (g)	84th-Percentile Spectral Acceleration (g)	Max Dir Scale factor	Max Dir Deterministic SA (g)
0.001	0.373	0.513	0.623	1.1	0.685
0.1	0.555	0.543	0.955	1.1	1.051
0.2	0.788	0.515	1.319	1.1	1.451
0.3	0.891	0.542	1.532	1.125	1.723
0.5	0.858	0.601	1.566	1.175	1.840
0.75	0.687	0.646	1.312	1.2375	1.624
1	0.571	0.675	1.121	1.3	1.457
2	0.316	0.705	0.640	1.35	0.864
3	0.209	0.710	0.426	1.4	0.597
4	0.149	0.701	0.299	1.45	0.434
5	0.108	0.702	0.219	1.5	0.328

**Deterministic Response Spectra per ASCE 7-16**

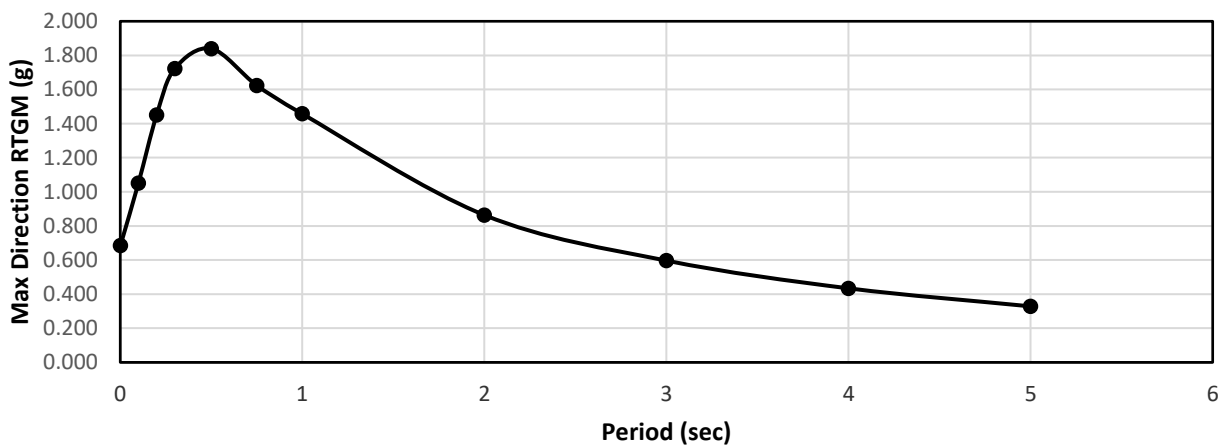



Latitude, Longitude: 33.843864, -118.282293



<b>Date</b>	1/29/2021, 10:28:27 AM
<b>Design Code Reference Document</b>	ASCE7-16
<b>Risk Category</b>	II
<b>Site Class</b>	D - Stiff Soil

Type	Value	Description
S <sub>S</sub>	1.726	MCE <sub>R</sub> ground motion. (for 0.2 second period)
S <sub>1</sub>	0.62	MCE <sub>R</sub> ground motion. (for 1.0s period)
S <sub>MS</sub>	1.726	Site-modified spectral acceleration value
S <sub>M1</sub>	null -See Section 11.4.8	Site-modified spectral acceleration value
S <sub>DS</sub>	1.151	Numeric seismic design value at 0.2 second SA
S <sub>D1</sub>	null -See Section 11.4.8	Numeric seismic design value at 1.0 second SA

Type	Value	Description
SDC	null -See Section 11.4.8	Seismic design category
F <sub>a</sub>	1	Site amplification factor at 0.2 second
F <sub>v</sub>	null -See Section 11.4.8	Site amplification factor at 1.0 second
PGA	0.752	MCE <sub>G</sub> peak ground acceleration
F <sub>PGA</sub>	1.1	Site amplification factor at PGA
PGA <sub>M</sub>	0.827	Site modified peak ground acceleration
T <sub>L</sub>	8	Long-period transition period in seconds
SsRT	1.726	Probabilistic risk-targeted ground motion. (0.2 second)
SsUH	1.916	Factored uniform-hazard (2% probability of exceedance in 50 years) spectral acceleration
SsD	2.399	Factored deterministic acceleration value. (0.2 second)
S1RT	0.62	Probabilistic risk-targeted ground motion. (1.0 second)
S1UH	0.691	Factored uniform-hazard (2% probability of exceedance in 50 years) spectral acceleration.
S1D	0.832	Factored deterministic acceleration value. (1.0 second)
PGAd	0.979	Factored deterministic acceleration value. (Peak Ground Acceleration)
C <sub>RS</sub>	0.901	Mapped value of the risk coefficient at short periods
C <sub>R1</sub>	0.897	Mapped value of the risk coefficient at a period of 1 s

## DISCLAIMER

While the information presented on this website is believed to be correct, SEAOC / OSHPD and its sponsors and contributors assume no responsibility or liability for its accuracy. The material presented in this web application should not be used or relied upon for any specific application without competent examination and verification of its accuracy, suitability and applicability by engineers or other licensed professionals. SEAOC / OSHPD do not intend that the use of this information replace the sound judgment of such competent professionals, having experience and knowledge in the field of practice, nor to substitute for the standard of care required of such professionals in interpreting and applying the results of the seismic data provided by this website. Users of the information from this website assume all liability arising from such use. Use of the output of this website does not imply approval by the governing building code bodies responsible for building code approval and interpretation for the building site described by latitude/longitude location in the search results of this website.



# Unified Hazard Tool



Please do not use this tool to obtain ground motion parameter values for the design code reference documents covered by the [U.S. Seismic Design Maps web tools](#) (e.g., the International Building Code and the ASCE 7 or 41 Standard). The values returned by the two applications are not identical.

## ^ Input

### Edition

### Spectral Period

### Latitude

Decimal degrees

### Time Horizon

Return period in years

### Longitude

Decimal degrees, negative values for western longitudes

### Site Class

# ^ Hazard Curve

Hazard Curves

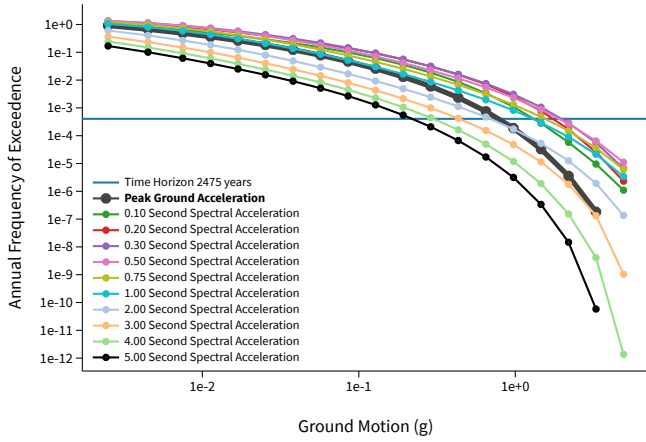

Uniform Hazard Response Spectrum

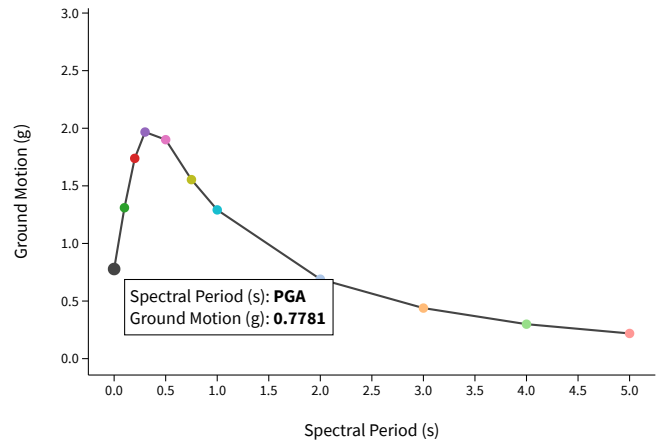

Component Curves for Peak Ground Acceleration

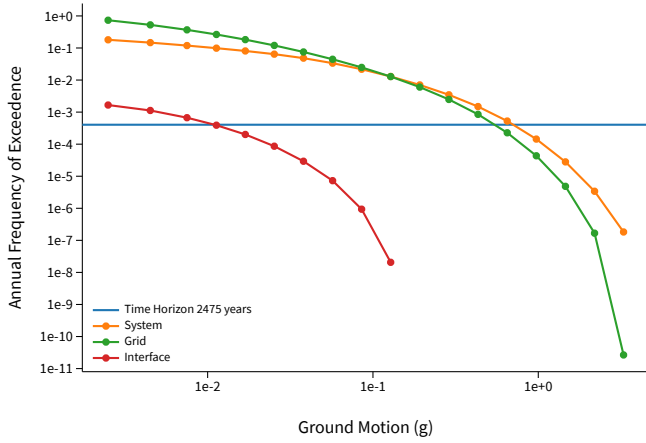

[View Raw Data](#)

^ Deaggregation

Component

Total

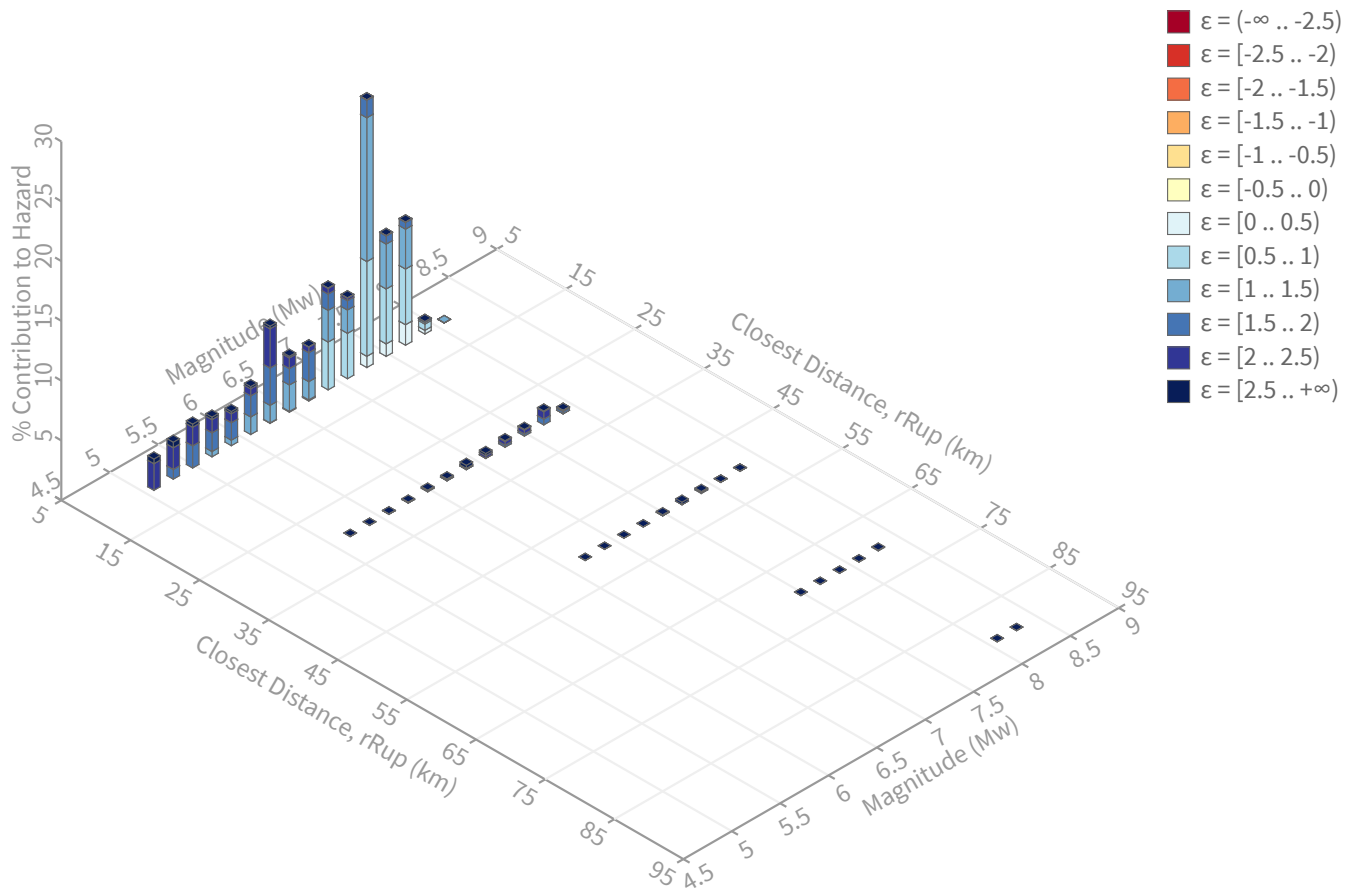

## Summary statistics for, Deaggregation: Total

### Deaggregation targets

**Return period:** 2475 yrs  
**Exceedance rate:** 0.0004040404 yr<sup>-1</sup>  
**PGA ground motion:** 0.77805471 g

### Recovered targets

**Return period:** 2925.0613 yrs  
**Exceedance rate:** 0.00034187318 yr<sup>-1</sup>

### Totals

**Binned:** 100 %  
**Residual:** 0 %  
**Trace:** 0.04 %

### Mean (over all sources)

**m:** 6.85  
**r:** 8.6 km  
**ε<sub>0</sub>:** 1.38 σ

### Mode (largest m-r bin)

**m:** 7.3  
**r:** 7.09 km  
**ε<sub>0</sub>:** 1.08 σ  
**Contribution:** 22.38 %

### Mode (largest m-r-ε<sub>0</sub> bin)

**m:** 7.3  
**r:** 7.6 km  
**ε<sub>0</sub>:** 1.28 σ  
**Contribution:** 12.02 %

### Discretization

**r:** min = 0.0, max = 1000.0, Δ = 20.0 km  
**m:** min = 4.4, max = 9.4, Δ = 0.2  
**ε:** min = -3.0, max = 3.0, Δ = 0.5 σ

### Epsilon keys

**ε0:** [-∞ .. -2.5)  
**ε1:** [-2.5 .. -2.0)  
**ε2:** [-2.0 .. -1.5)  
**ε3:** [-1.5 .. -1.0)  
**ε4:** [-1.0 .. -0.5)  
**ε5:** [-0.5 .. 0.0)  
**ε6:** [0.0 .. 0.5)  
**ε7:** [0.5 .. 1.0)  
**ε8:** [1.0 .. 1.5)  
**ε9:** [1.5 .. 2.0)  
**ε10:** [2.0 .. 2.5)  
**ε11:** [2.5 .. +∞]

## Deaggregation Contributors

Source Set ↪ Source	Type	r	m	$\epsilon_0$	lon	lat	az	%
UC33brAvg_FM31	System							38.93
Palos Verdes [11]		7.80	7.22	1.35	118.331°W	33.788°N	215.91	10.99
Newport-Inglewood alt 1 [5]		4.22	7.39	0.86	118.249°W	33.866°N	51.56	10.06
Compton [2]		6.84	7.30	0.73	118.295°W	33.821°N	205.46	6.32
Newport-Inglewood alt 1 [7]		10.51	6.36	2.00	118.316°W	33.933°N	342.70	2.24
Newport-Inglewood alt 1 [6]		5.21	7.00	0.98	118.265°W	33.886°N	18.63	1.82
Compton [1]		6.92	6.99	0.87	118.286°W	33.817°N	185.97	1.81
UC33brAvg_FM32	System							35.48
Palos Verdes [11]		7.80	7.36	1.31	118.331°W	33.788°N	215.91	9.87
Newport-Inglewood alt 2 [5]		4.75	7.39	0.91	118.244°W	33.869°N	51.66	7.28
Compton [2]		6.84	7.36	0.72	118.295°W	33.821°N	205.46	6.90
Newport-Inglewood alt 2 [6]		5.09	7.06	0.92	118.256°W	33.882°N	29.82	2.11
Newport-Inglewood alt 2 [7]		10.28	6.37	1.97	118.305°W	33.933°N	348.35	1.70
Compton [1]		6.92	6.97	0.87	118.286°W	33.817°N	185.97	1.51
Puente Hills (Santa Fe Springs) [1]		16.24	7.17	1.93	118.144°W	33.926°N	54.29	1.09
Palos Verdes [12]		8.68	6.62	1.70	118.359°W	33.800°N	235.26	1.03
UC33brAvg_FM31 (opt)	Grid							12.99
PointSourceFinite: -118.282, 33.893		7.40	5.66	1.71	118.282°W	33.893°N	0.00	1.87
PointSourceFinite: -118.282, 33.893		7.40	5.66	1.71	118.282°W	33.893°N	0.00	1.87
PointSourceFinite: -118.282, 33.902		7.88	5.77	1.74	118.282°W	33.902°N	0.00	1.86
PointSourceFinite: -118.282, 33.902		7.88	5.77	1.74	118.282°W	33.902°N	0.00	1.86
PointSourceFinite: -118.282, 33.929		9.93	5.85	1.98	118.282°W	33.929°N	0.00	1.45
PointSourceFinite: -118.282, 33.929		9.93	5.85	1.98	118.282°W	33.929°N	0.00	1.45
UC33brAvg_FM32 (opt)	Grid							12.60
PointSourceFinite: -118.282, 33.893		7.41	5.66	1.72	118.282°W	33.893°N	0.00	1.83
PointSourceFinite: -118.282, 33.893		7.41	5.66	1.72	118.282°W	33.893°N	0.00	1.83
PointSourceFinite: -118.282, 33.902		7.88	5.77	1.75	118.282°W	33.902°N	0.00	1.79
PointSourceFinite: -118.282, 33.902		7.88	5.77	1.75	118.282°W	33.902°N	0.00	1.79
PointSourceFinite: -118.282, 33.929		9.95	5.84	1.99	118.282°W	33.929°N	0.00	1.38
PointSourceFinite: -118.282, 33.929		9.95	5.84	1.99	118.282°W	33.929°N	0.00	1.38

**APPENDIX E  
STANDARD GRADING GUIDELINES**

## **STANDARD GRADING SPECIFICATIONS**

These specifications present the usual and minimum requirements for grading operations performed under the observation and testing of TGR Geotechnical, Inc.

No deviation from these specifications will be allowed, except where specifically superseded in the Preliminary Geotechnical Investigation report, or in other written communication signed by the Soils Engineer or Engineering Geologist.

### **1.0 GENERAL**

- The Soils Engineer and Engineering Geologist are the Owner's or Builder's representatives on the project. For the purpose of these specifications, observation and testing by the Soils Engineer includes that observation and testing performed by any person or persons employed by, and responsible to, the licensed Geotechnical Engineer or Geologist signing the grading report.
- All clearing, site preparation or earthwork performed on the project shall be conducted by the Contractor under the observation of the Geotechnical Engineer.
- It is the Contractor's responsibility to prepare the ground surface to receive the fills to the satisfaction of the Geotechnical Engineer and to place, spread, mix, water and compact the fill in accordance with the specifications of the Geotechnical Engineer. The Contractor shall also remove all material considered unsatisfactory by the Geotechnical Engineer.
- It is also the Contractor's responsibility to have suitable and sufficient compaction equipment on the job site to handle the amount of fill being placed. If necessary, excavation equipment will be shut down to permit completion of Compaction. Sufficient watering apparatus will also be provided by the Contractor, with due consideration for the fill material, rate of placement and time of year.
- A final report will be issued by the Geotechnical Engineer and Engineering Geologist attesting to the Contractor's conformance with these specifications.

**2.0 SITE PREPARATION**

- All vegetation and deleterious material such as rubbish shall be disposed of off-site. The removal must be concluded prior to placing fill.
- The Civil Engineer shall locate all houses, sheds, sewage disposal systems, large trees or structures on the site, or on the grading plan to the best of his knowledge prior to preparing the ground surface.
- Soil, alluvium or rock materials determined by the Geotechnical Engineer as being unsuitable for placement in compacted fills shall be removed and wasted from the site. Any material incorporated as part of a compacted fill must be approved by the Geotechnical Engineer.
- After the ground surface to receive fill has been cleared, it shall be scarified, disced or bladed by the Contractor until it is uniform and free from ruts, hollows, hummocks or other uneven features which may prevent uniform compaction.

The scarified ground surface shall then be brought to optimum moisture content, mixed as required, and compacted as specified. If the scarified zone is greater than twelve inches in depth, the excess shall be removed and placed in lifts restricted to six inches. Prior to placing fill, the ground surface to receive fill shall be inspected, tested and approved by the Geotechnical Engineer.

- Any underground structures such as cesspools, cisterns, mining shafts, tunnels, septic tanks, wells, pipe lines or others not located prior to grading are to be removed or treated in a manner prescribed by the Geotechnical Engineer.

**3.0 COMPACTED FILLS**

- Any material imported or excavated on the property may be utilized in the fill, provided each material has been determined to be suitable by the Geotechnical Engineer. Roots, tree branches and other matter missed during clearing shall be removed from the fill as directed by the Geotechnical Engineer.
- Rock fragments less than six inches in diameter may be utilized in the fill, provided:



- They are not placed in concentrated pockets.
  - There is a sufficient percentage of fine-grained material to surround the rocks.
  - The distribution of the rocks is observed by the Geotechnical Engineer.
- Rocks greater than six inches in diameter shall be taken off-site, or placed in accordance with the recommendations of the Geotechnical Engineer in areas designated as suitable for rock disposal. Details for rock disposal such as location, moisture control, percentage of the rock placed, etc., will be referred to in the “Conclusions and Recommendations” section of the Geotechnical Report, if applicable.

If rocks greater than six inches in diameter were not anticipated in the Preliminary Geotechnical report, rock disposal recommendations may not have been made in the “Conclusions and Recommendations” section. In this case, the Contractor shall notify the Geotechnical Engineer if rocks greater than six inches in diameter are encountered. The Geotechnical Engineer will then prepare a rock disposal recommendation or request that such rocks be taken off-site.

- Material that is spongy, subject to decay, or otherwise considered unsuitable shall not be used in the compacted fill.
- Representative samples of materials to be utilized as compacted fill shall be analyzed in the laboratory by the Geotechnical Engineer to determine their physical properties. If any material other than that previously tested is encountered during grading, the appropriate analysis of this material shall be conducted by the Geotechnical Engineer as soon as possible.
- Material used in the compacting process shall be evenly spread, watered or dried, processed and compacted in thin lifts not to exceed six inches in thickness to obtain a uniformly dense layer. The fill shall be placed and compacted on a horizontal plane, unless otherwise approved by the Geotechnical Engineer.

- If the moisture content or relative compaction varies from that required by the Geotechnical Engineer, the Contractor shall rework the fill until it is approved by the Geotechnical Engineer.
- Each layer shall be compacted to 90 percent of the maximum dry density in compliance with the testing method specified by the controlling governmental agency; (in general, ASTM D1557 will be used.)

If compaction to a lesser percentage is authorized by the controlling governmental agency because of a specific land use or expansive soil conditions, the area to receive fill compacted to less than 90 percent shall either be delineated on the grading plan or appropriate reference made to the area in the grading report.

- All fill shall be keyed and benched through all topsoil, colluvium, alluvium or creep material, into sound bedrock or firm material where the slope receiving fill exceeds a ratio of five horizontal to one vertical, in accordance with the recommendations of the Geotechnical Engineer.
- The key for side hill fills shall be a minimum of 15 feet within bedrock or firm materials, unless otherwise specified in the Preliminary report. (See details)
- Drainage terraces and subdrainage devices shall be constructed in compliance with the ordinances of the controlling governmental agency, or with the recommendation of the Geotechnical Engineer and Engineer Geologist.
- The Contractor will be required to obtain a minimum relative compaction of 90 percent out to the finish slope face of fill slopes, buttresses and stabilization fills. This may be achieved by either overbuilding the slope and cutting back to the compacted core, or by direct compaction of the slope face with suitable equipment, or by any other procedure which produces the required compaction.

The Contractor shall prepare a written detailed description of the method or methods he will employ to obtain the required slope compaction. Such documents shall be submitted to the Geotechnical Engineer for review and comments prior to the start of grading.

If a method other than overbuilding and cutting back to the compacted core is to be employed, slope tests will be made by the Geotechnical Engineer during construction of the slopes to determine if the required compaction is being achieved. Where failing tests occur or other field problems arise, the contractor will be notified by the Geotechnical Engineer.

If the method of achieving the required slope compaction selected by the Contractor fails to produce the necessary results, the Contractor shall rework or rebuild such slopes until the required degree of compaction is obtained, at no additional cost to the Owner or Geotechnical Engineer.

- All fill slopes should be planted or protected from erosion by methods specified in the preliminary report or by means approved by the governing authorities.
- Fill-over-cut slopes shall be properly keyed through topsoil, colluvium or creep material into rock or firm materials; and the transition shall be stripped of all soil prior to placing fill. (See detail)

#### **4.0 CUT SLOPES**

- The Engineering Geologist shall inspect all cut slopes excavated in rock, lithified or formation material at vertical intervals not exceeding ten feet.
- If any conditions not anticipated in the preliminary report such as perched water, seepage, lenticular or confined strata of a potentially adverse nature, unfavorably inclined bedding, joints or fault planes are encountered during grading, these

conditions shall be analyzed by the Engineering Geologist and Geotechnical Engineer; and recommendations shall be made to treat these problems.

- Cut slopes that face in the same direction as the prevailing drainage shall be protected from slope wash by a non-erosive interceptor swale placed at the top of the slope.
- Unless otherwise specified in the soils and geological report, no cut slopes shall be excavated higher or steeper than that allowed by the ordinances of controlling governmental agencies.
- Drainage terraces shall be constructed in compliance with the ordinances of controlling governmental agencies, or with the recommendations of the Geotechnical Engineer or Engineering Geologist.

## **5.0 GRADING CONTROL**

- Inspection of the fill placement shall be provided by the Geotechnical Engineer during the progress of grading.
- In general, density tests should be made at intervals not exceeding two feet of fill height or every 500 cubic yards of fill placed. This criteria will vary depending on soil conditions and the size of the job. In any event, an adequate number of field density tests shall be made to verify that the required compaction of being achieved.
- Density tests should be made on the surface material to receive fill as required by the Geotechnical Engineer.
- All cleanout, processed ground to receive fill, key excavations, subdrains and rock disposal must be inspected and approved by the Geotechnical Engineer (and often by the governing authorities) prior to placing any fill. It shall be the Contractor's responsibility to notify the Geotechnical Engineer and governing authorities when such areas are ready for inspection.

**6.0 CONSTRUCTION CONSIDERATIONS**

- Erosion control measures, when necessary, shall be provided by the Contractor during grading and prior to the completion and construction of permanent drainage controls.
- Upon completion of grading and termination of observations by the Geotechnical Engineer, no further filling or excavating, including that necessary for footings, foundations, large tree wells, retaining walls, or other features shall be performed without the approval of the Geotechnical Engineer or Engineering Geologist.
- Care shall be taken by the Contractor during final grading to preserve any berms, drainage terraces, interceptor swales, or other devices of a permanent nature on or adjacent to the property.

# TYPICAL OVEREXCAVATION OF DAYLIGHT LINE

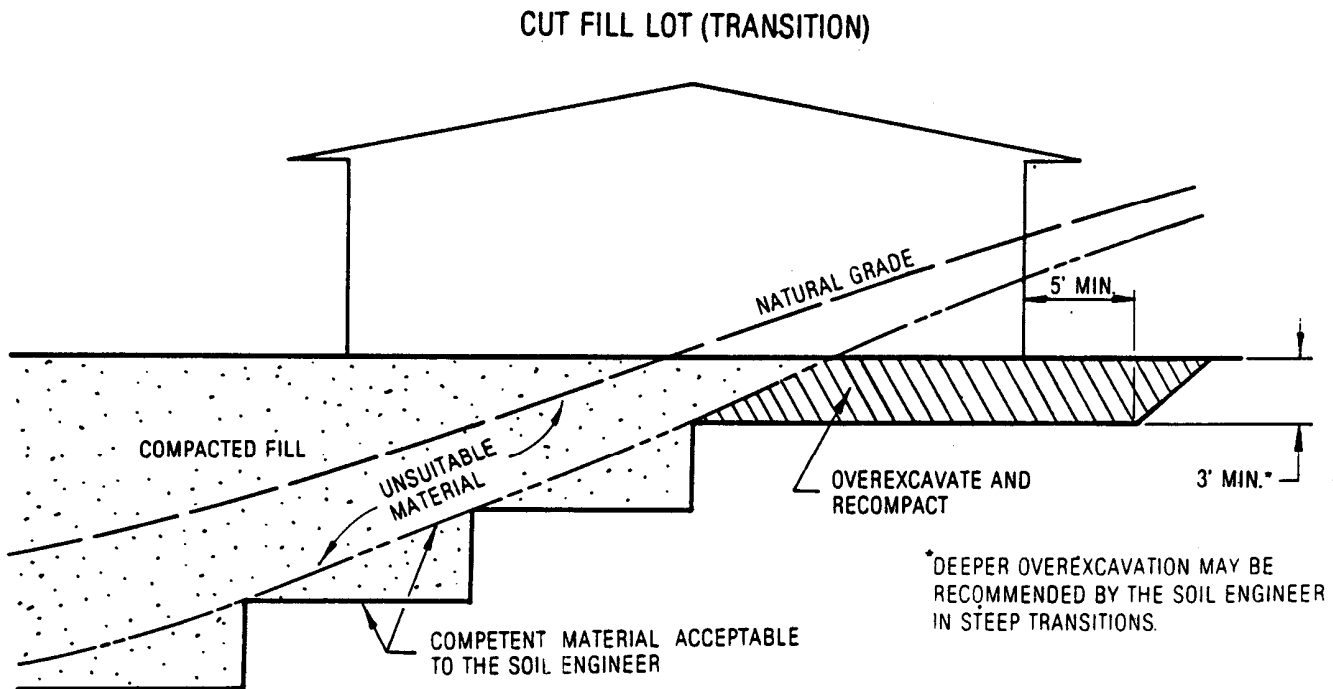
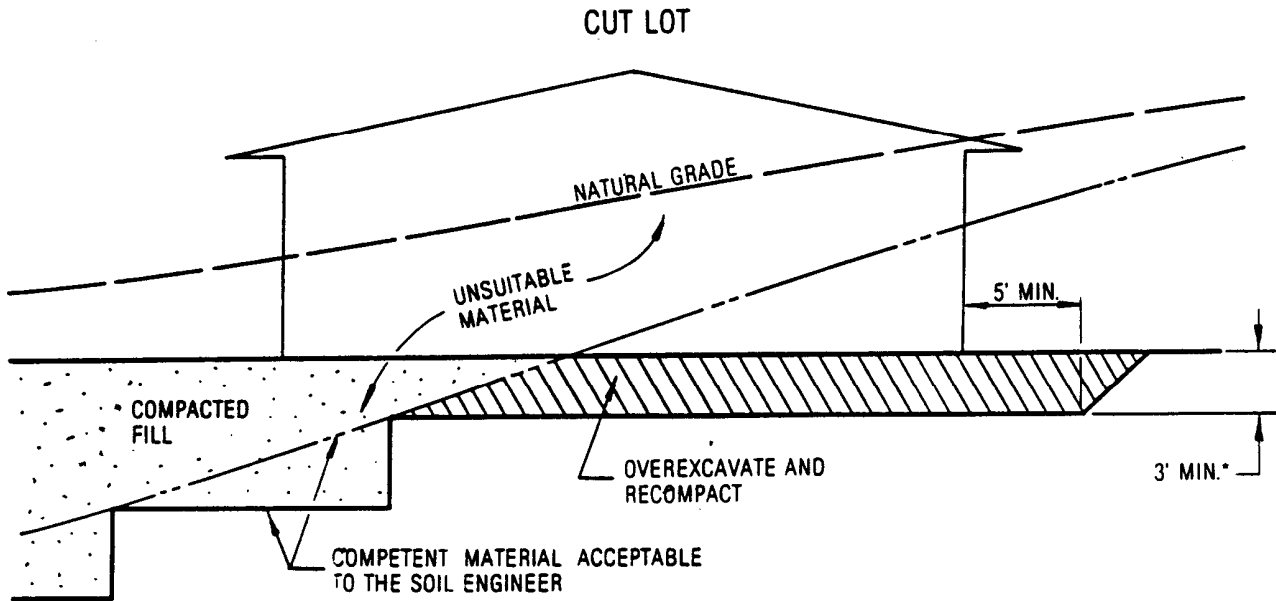

# TYPICAL FILL OVER NATURAL SLOPE

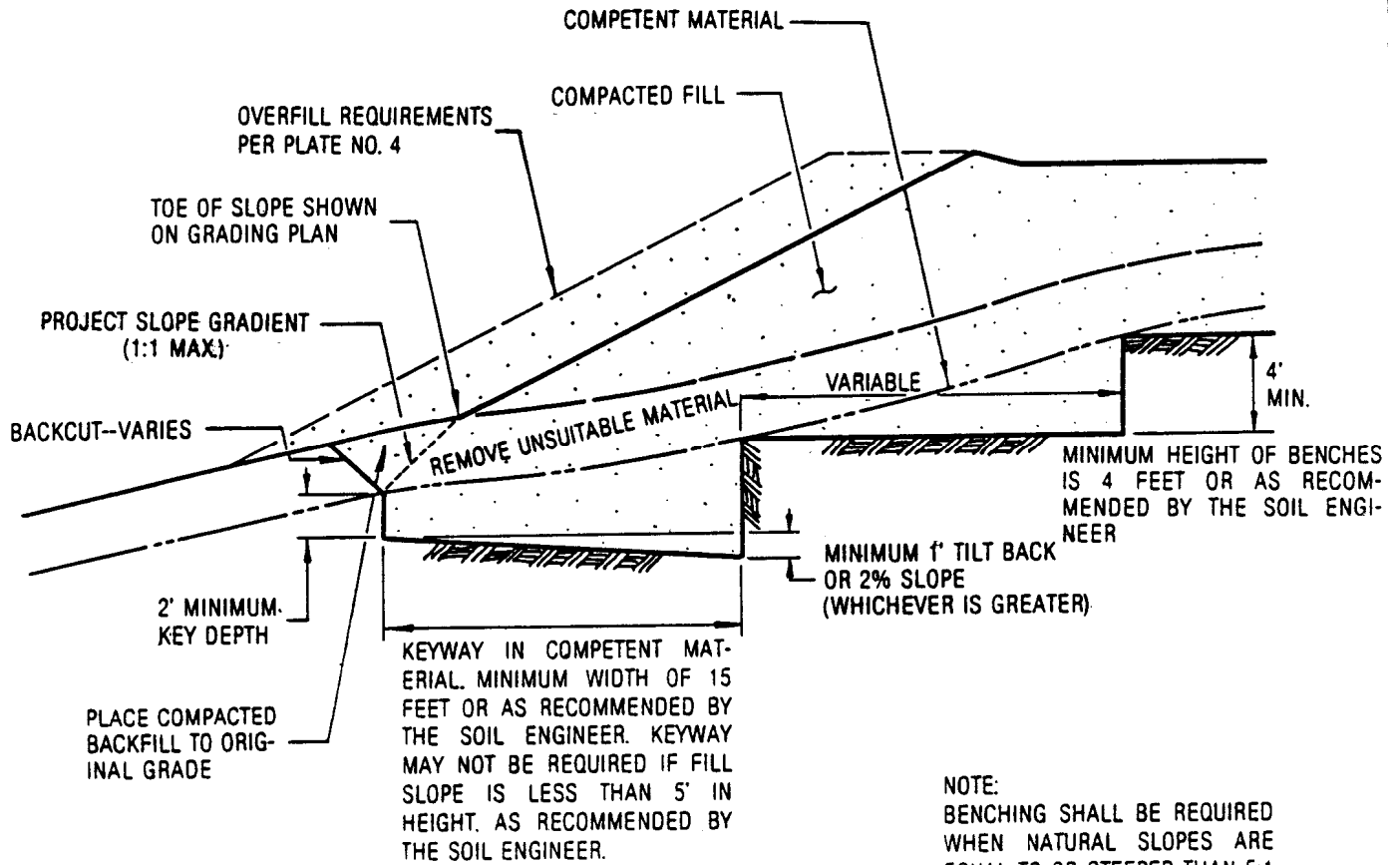

NOTE:  
 BENCHING SHALL BE REQUIRED  
 WHEN NATURAL SLOPES ARE  
 EQUAL TO OR STEEPER THAN 5:1  
 OR WHEN RECOMMENDED BY  
 THE SOIL ENGINEER.

# TYPICAL FILL-OVER-CUT SLOPE

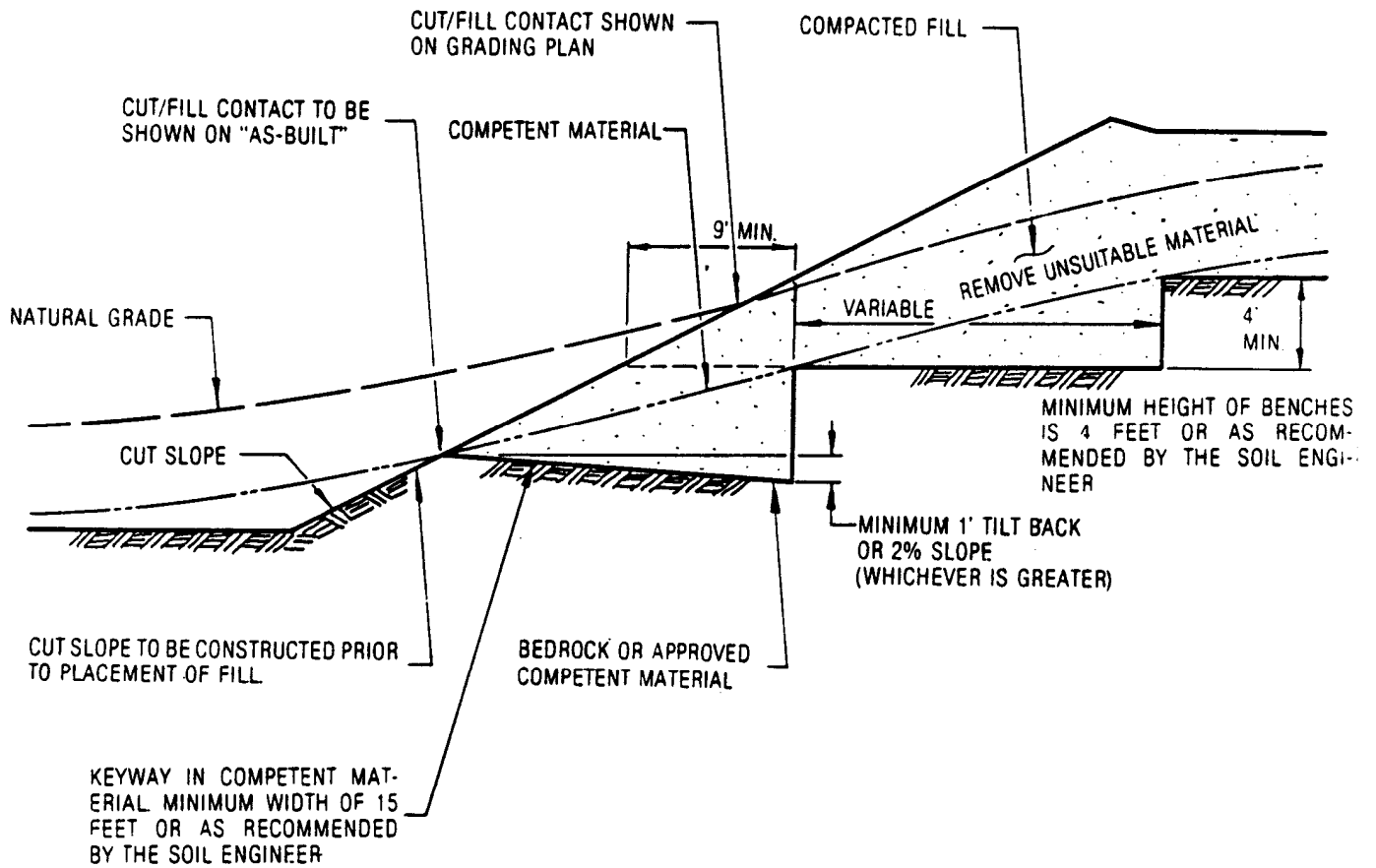



# TYPICAL FILL SLOPE CONSTRUCTION

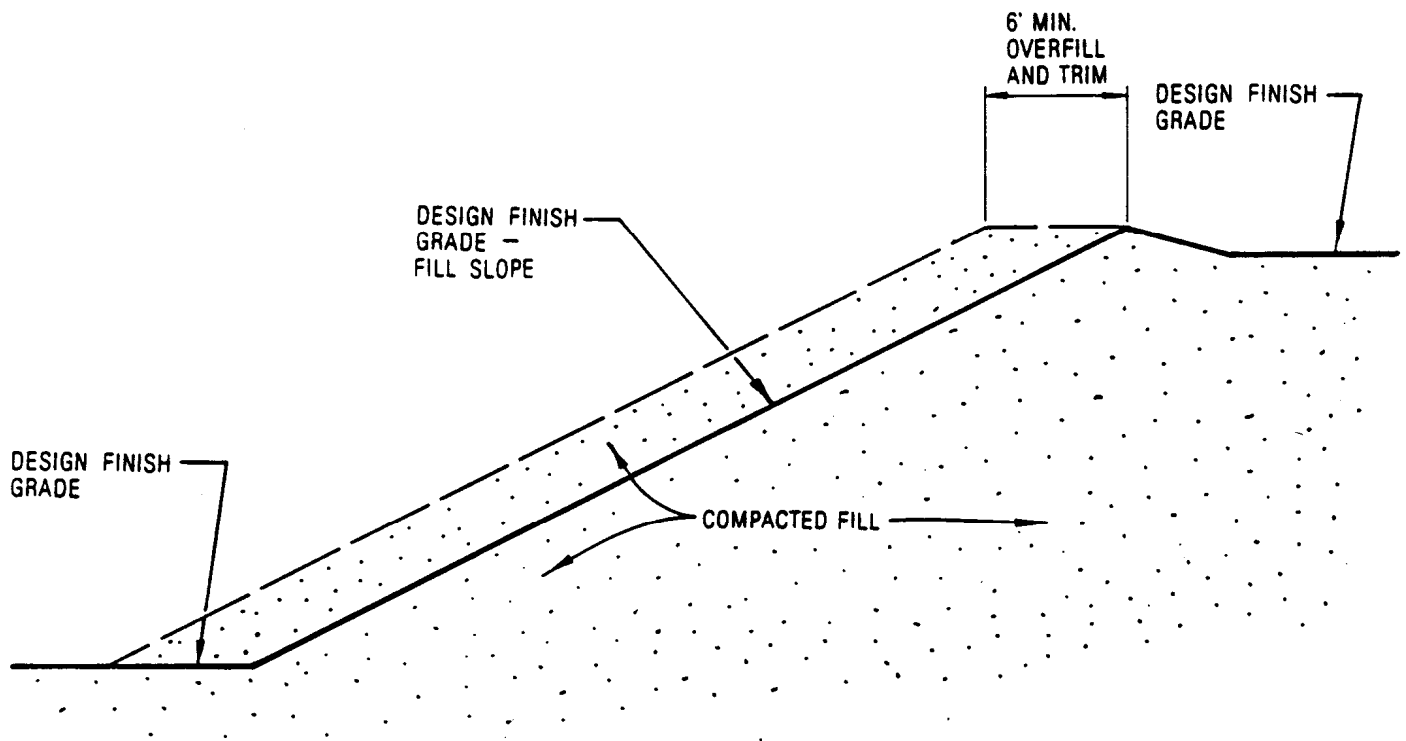

## NOTES:

1. ALL FILL SLOPES, INCLUDING BUTTRESS AND STABILIZATION FILLS, SHALL BE OVERFILLED A MINIMUM OF SIX FEET HORIZONTALLY WITH COMPACTED FILL AND TRIMMED TO THE DESIGN FINISH GRADE.

### EXCEPTIONS:

- A. FILL SLOPE OVER CUT SLOPE.
  - B. FILL SLOPE ADJACENT TO EXISTING IMPROVEMENTS.
2. THE EXCEPTIONS ABOVE WHICH DO NOT HAVE THE 6 FOOT SLOPE OVERFILL AND TRIM SHALL BE COMPACTED AS STATED IN THE PROJECT SPECIFICATIONS.

# TYPICAL STABILIZATION FILL

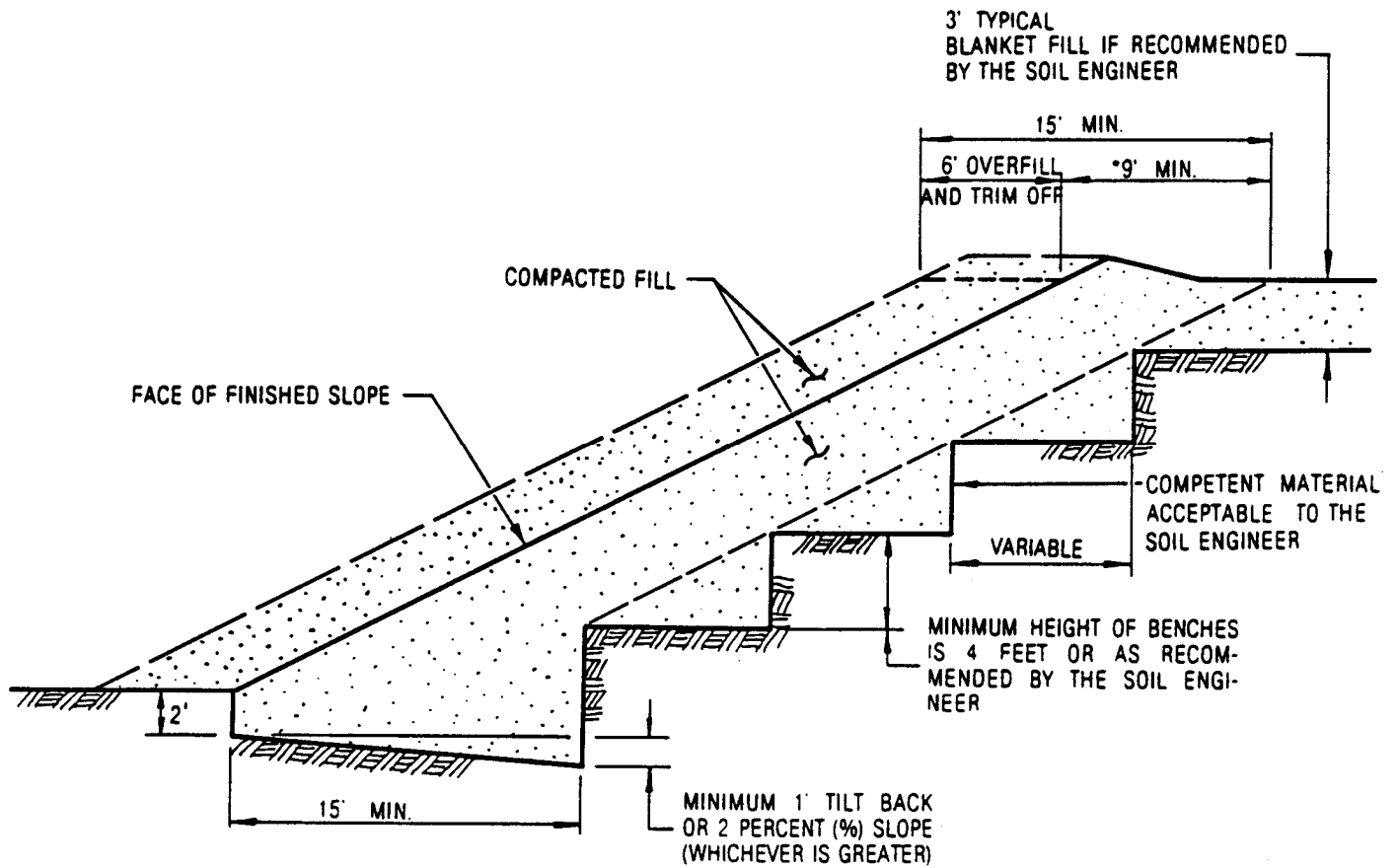

NOTE:  
SEE PLATE 6 FOR TYPICAL  
SUBDRAIN DETAILS FOR STA-  
BILIZATION FILLS. IF RECOM-  
MENDED BY THE SOIL ENGI-  
NEER.

\*GREATER THAN 9' IF RECOM-  
MENDED BY THE SOIL ENGINEER.  
15' WHERE NO 6' OVERFILL

# TYPICAL CANYON SUBDRAIN

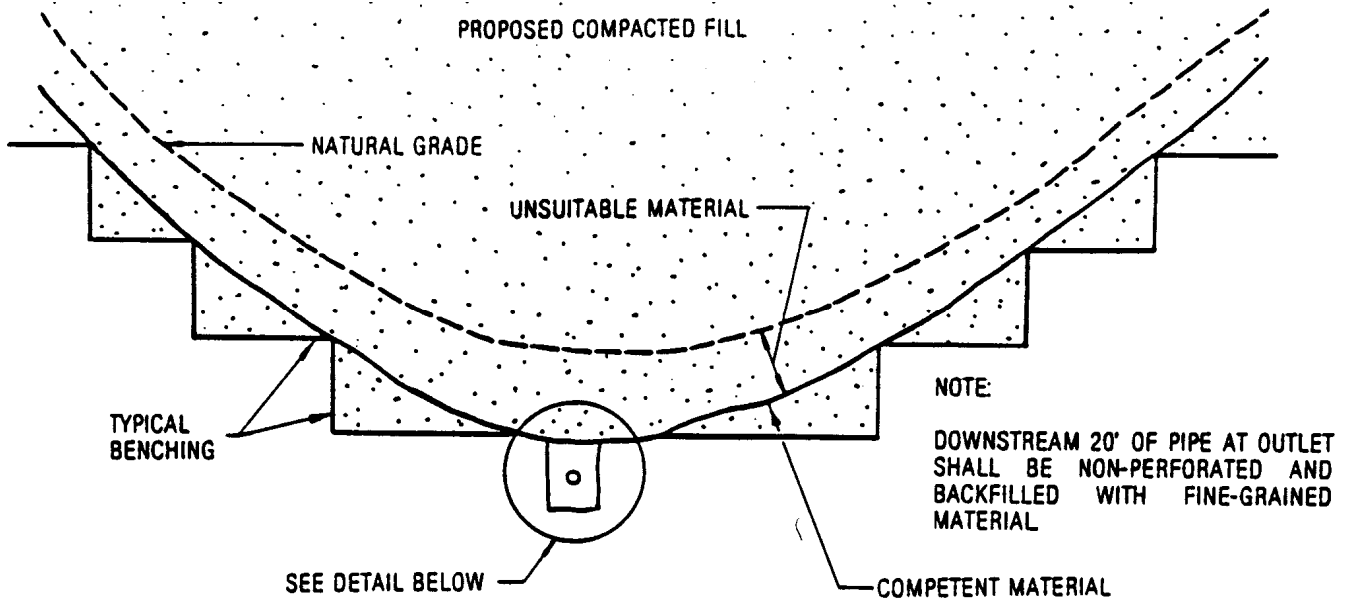

NOTES:  
PIPE SHALL BE A MINIMUM OF 4 INCHES DIAMETER AND RUNS OF 500 FEET OR MORE USE 6-INCH DIAMETER PIPE, OR AS RECOMMENDED BY THE SOIL ENGINEER

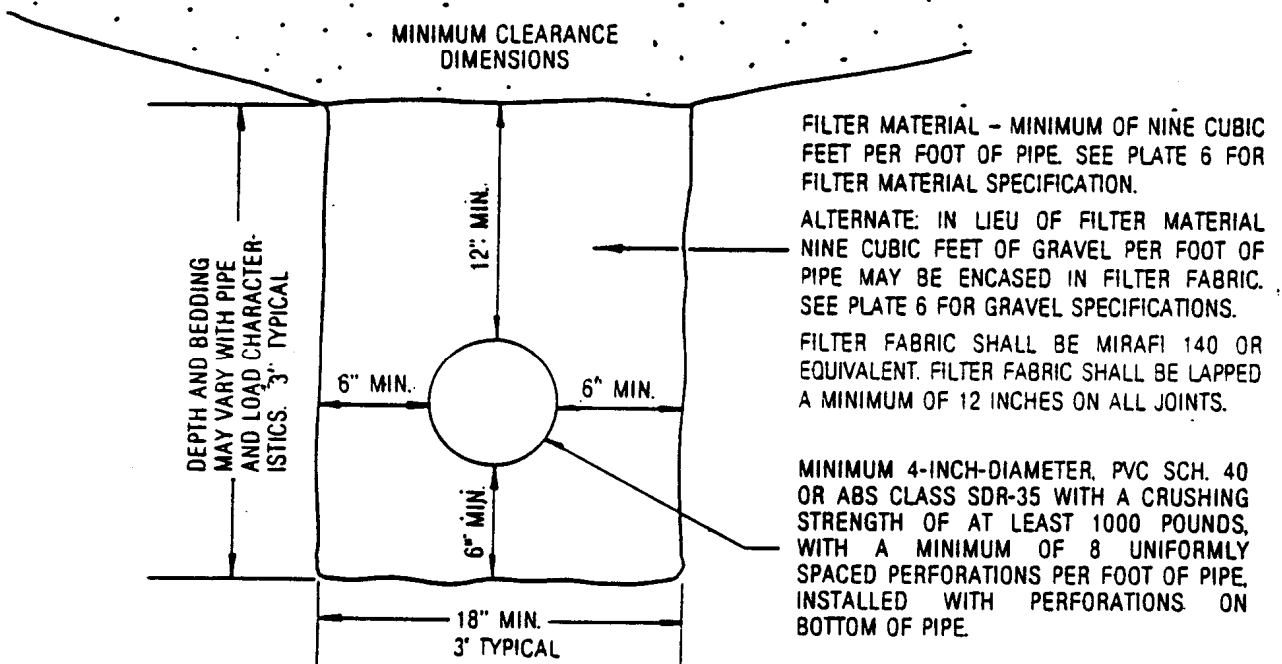

# SUBDRAIN OUTLET MARKER

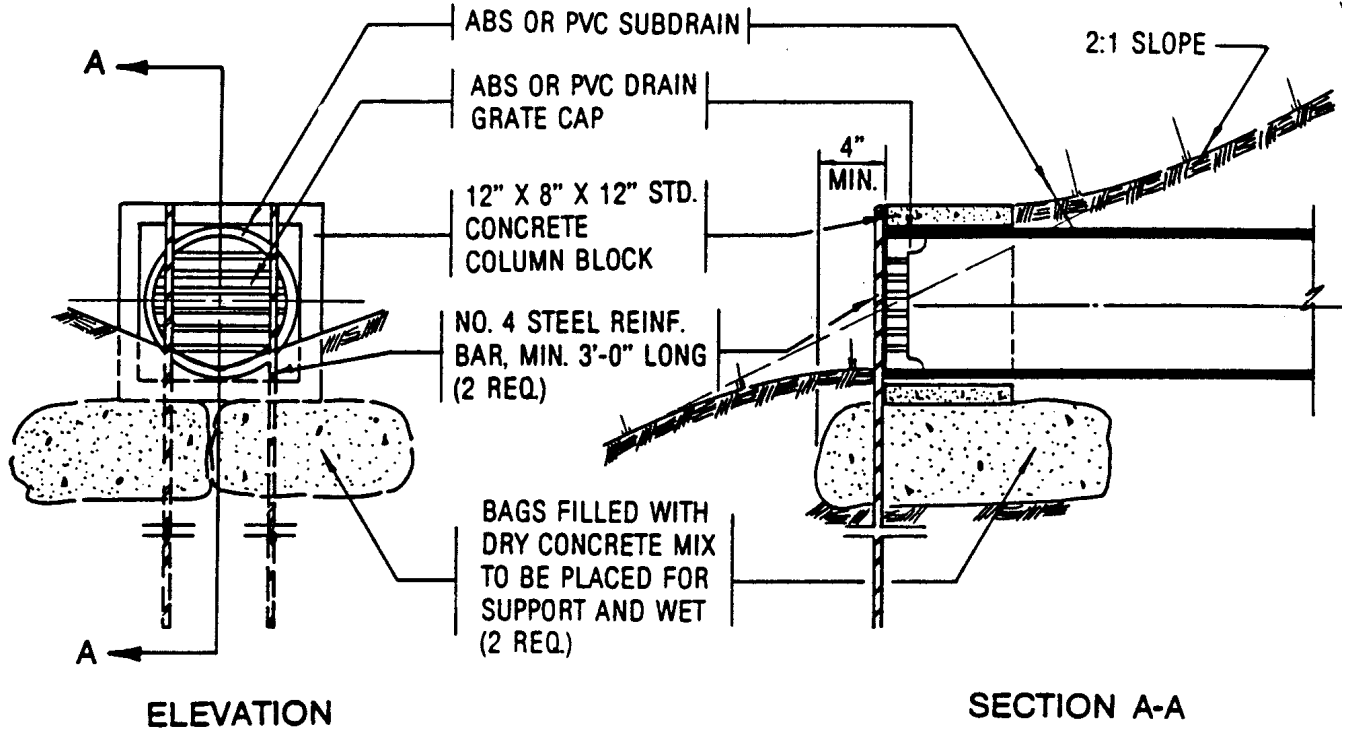

## SUBDRAIN OUTLET MARKER FOR 6" AND 8" PIPES

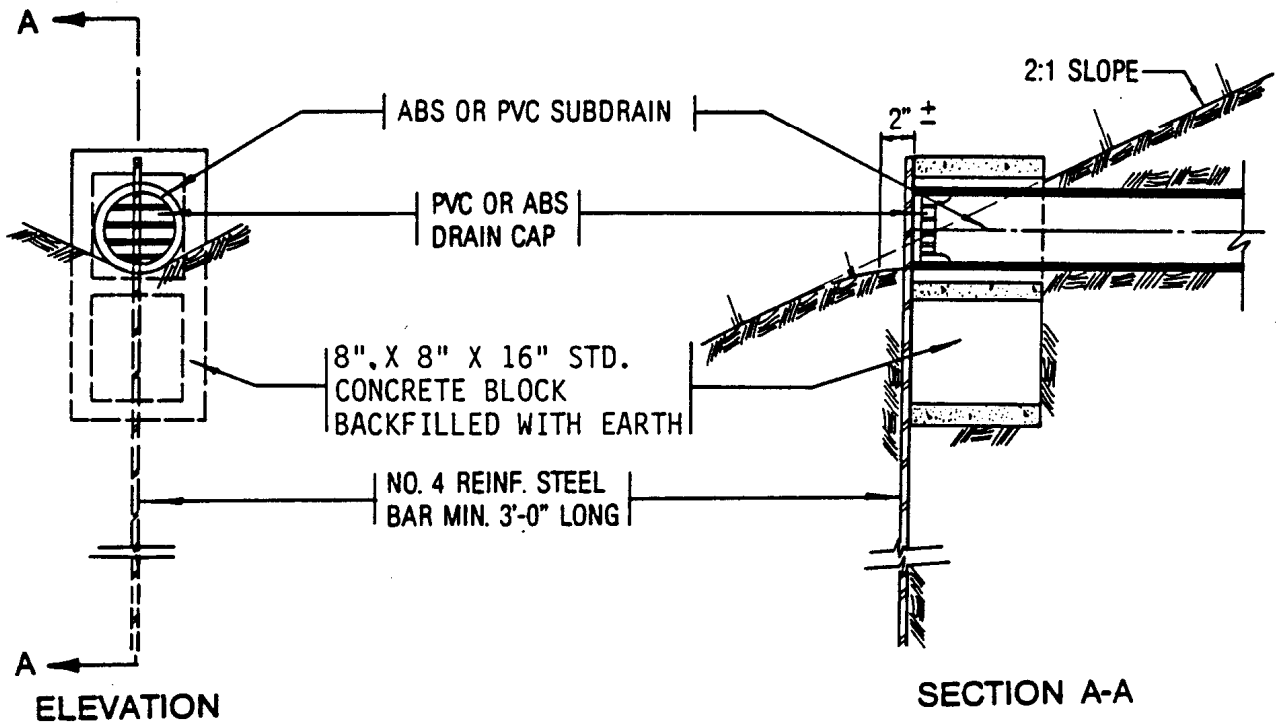

## SUBDRAIN OUTLET MARKER - 4" PIPE

# TYPICAL STABILIZATION AND BUTTRESS FILL SUBDRAIN

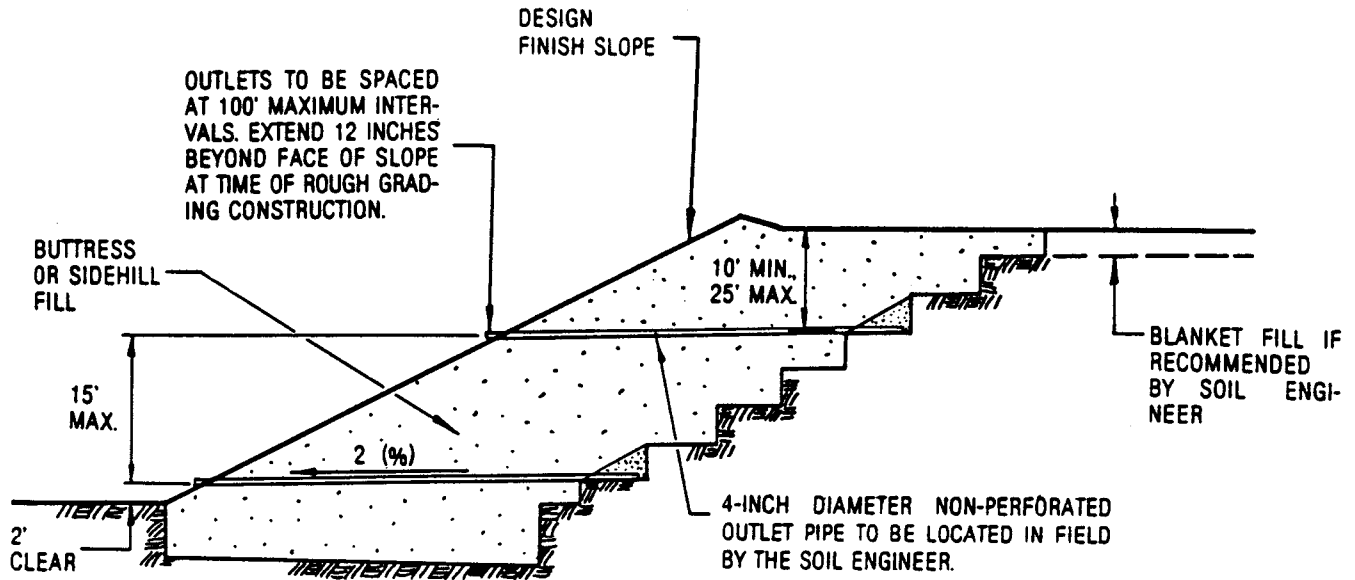

FILTER MATERIAL TO MEET FOLLOWING SPECIFICATION OR APPROVED EQUIVALENT: (CONFORMS TO MA STD. PLAN 323)

SIEVE SIZE	PERCENTAGE PASSING
1"	100
3/4"	90-100
3/8"	40-100
NO. 4	25-40
NO. 8	18-33
NO. 30	5-15
NO. 50	0-7
NO. 200	0-3

"GRAVEL" TO MEET FOLLOWING SPECIFICATION OR APPROVED EQUIVALENT:

SIEVE SIZE	MAXIMUM PERCENTAGE PASSING
1 1/2"	100
NO. 4	50
NO. 200	8

SAND EQUIVALENT = MINIMUM OF 50

FILTER MATERIAL - MINIMUM OF FIVE CUBIC FEET PER FOOT OF PIPE. SEE ABOVE FOR FILTER MATERIAL SPECIFICATION.

ALTERNATIVE: IN LIEU OF FILTER MATERIAL FIVE CUBIC FEET OF GRAVEL PER FOOT OF PIPE MAY BE ENCASED IN FILTER FABRIC. SEE ABOVE FOR GRAVEL SPECIFICATION.

FILTER FABRIC SHALL BE MIRAFI 140 OR EQUIVALENT. FILTER FABRIC SHALL BE LAPPED A MINIMUM OF 12 INCHES ON ALL JOINTS.

MINIMUM 4-INCH DIAMETER PVC SCH 40 OR ABS CLASS SDR 35 WITH A CRUSHING STRENGTH OF AT LEAST 1,000 POUNDS, WITH A MINIMUM OF 8 UNIFORMLY SPACED PERFORATIONS PER FOOT OF PIPE INSTALLED WITH PERFORATIONS ON BOTTOM OF PIPE. PROVIDE CAP AT UPSTREAM END OF PIPE. SLOPE AT 2 PERCENT TO OUTLET PIPE.

OUTLET PIPE TO BE CONNECTED TO SUBDRAIN PIPE WITH TEE OR ELBOW

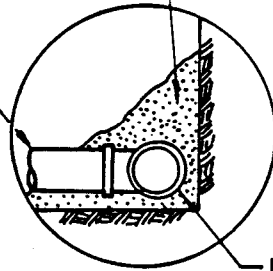

**NOTES:**

- TRENCH FOR OUTLET PIPES TO BE BACKFILLED WITH ON-SITE SOIL.

# TYPICAL CUT AND FILL GRADING DETAILS

## TYPICAL GRADING WITHIN PROPOSED DEEP BEDROCK CUT AREAS

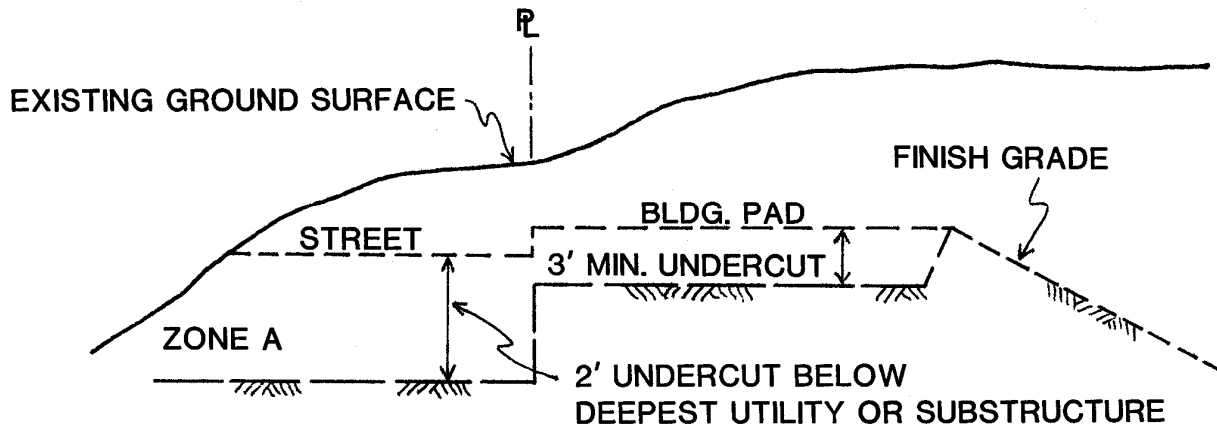

## TYPICAL GRADING WITHIN PROPOSED FILL AREAS

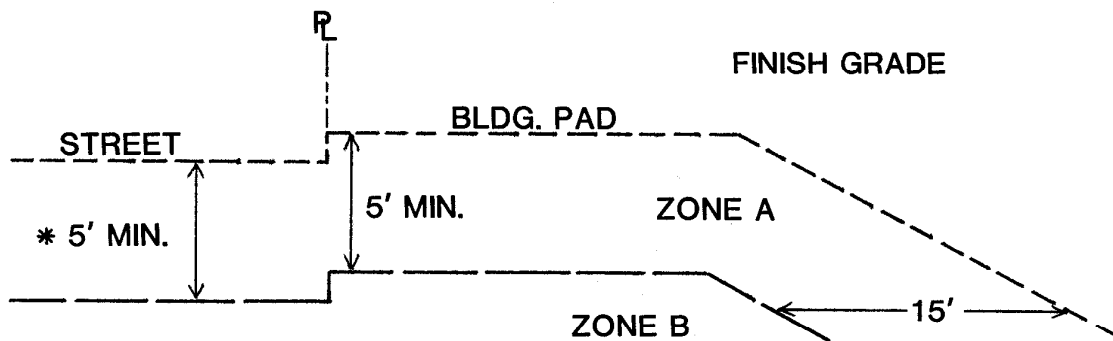

### LEGEND

ZONE A ..... "SOIL" FILL PLACED IN ACCORDANCE WITH THE RECOMMENDATIONS PRESENTED IN SECTION 11.2.3 OF THIS REPORT

ZONE B ..... "SOIL-ROCK" AND/OR "ROCK" FILL PLACED IN ACCORDANCE WITH THE RECOMMENDATIONS PRESENTED IN SECTION 11.2.3 OF THIS REPORT

\* 5' OR 1' BELOW DEEPEST UTILITY, WHICHEVER IS GREATER

# TYPICAL OVERSIZE ROCK DISPOSAL – “SOIL-ROCK” FILL

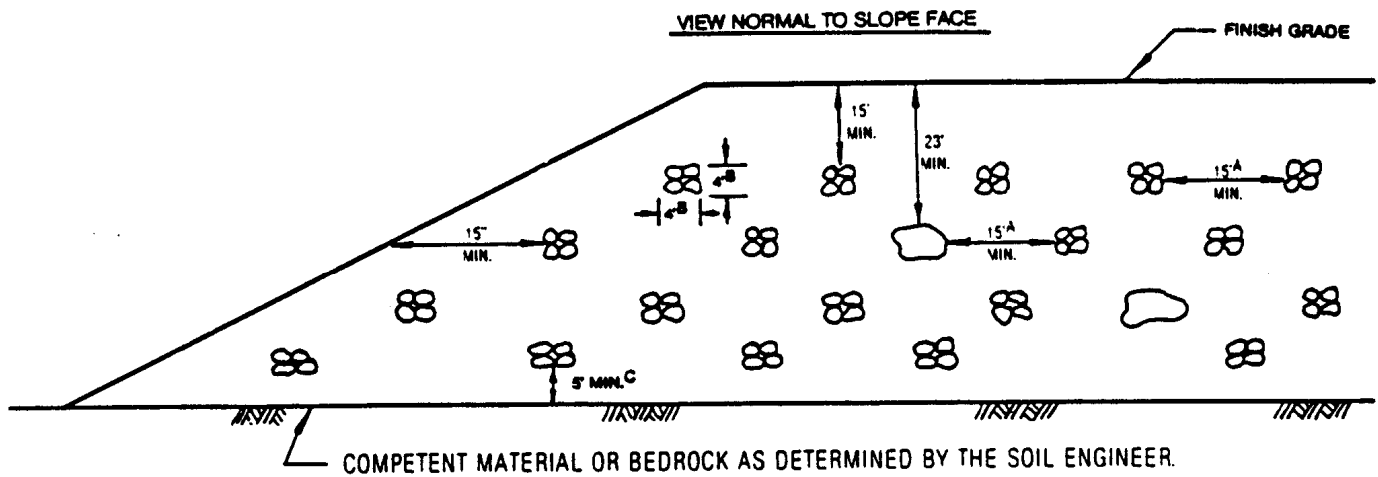

NOTE:  
ORIENTATION OF WINDROWS MAY VARY BUT SHALL BE AS RECOMMENDED BY SOIL ENGINEER.

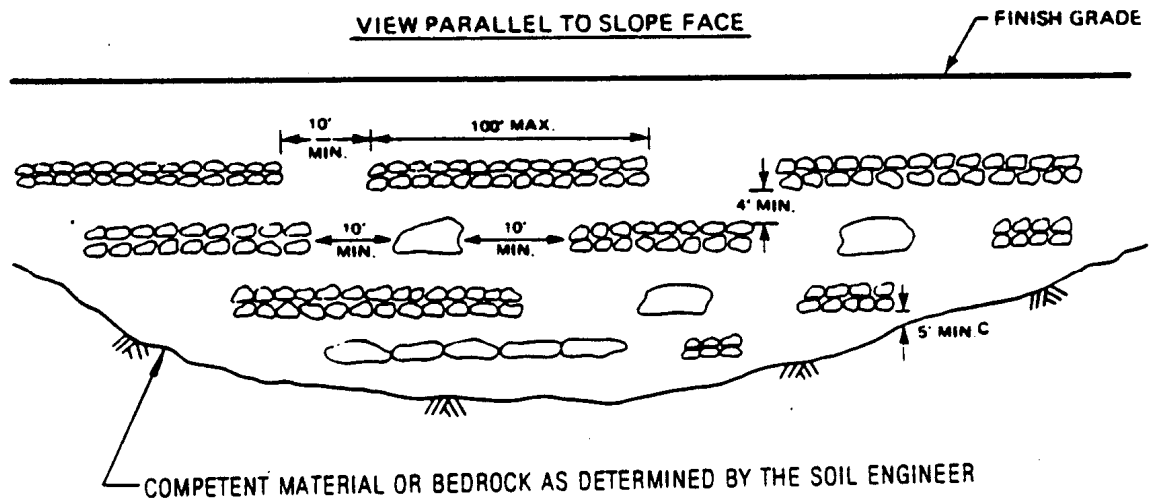

NOTES:

- A. ONE EQUIPMENT WIDTH OR A MINIMUM OF 15 FEET.
- B. HEIGHT AND WIDTH MAY VARY DEPENDING ON ROCK SIZE AND TYPE OF EQUIPMENT.
- C. IF APPROVED BY THE SOIL ENGINEER, WINDROWS MAY BE PLACED DIRECTLY ON COMPETENT MATERIALS OR BEDROCK PROVIDING ADEQUATE SPACE IS AVAILABLE FOR COMPACTION.
- D. VOIDS IN WINDROW TO BE FILLED BY FLOODING GRANULAR SOIL INTO PLACE. GRANULAR SOIL SHALL MEAN ANY SOIL WHICH HAS A UNIFIED SOIL CLASSIFICATION SYSTEM (UBC 29-1) DESIGNATION OF SM, SP, SW, GM, GP, OR GW.
- E. AFTER FILL BETWEEN WINDROWS IS PLACED AND COMPACTED WITH THE LIFT OF FILL COVERING WINDROW, WINDROW SHALL BE PROOF-ROLLED WITH D-9 DOZER OR EQUIVALENT.
- F. OVERSIZED ROCK IS DEFINED AS LARGER THAN 12" IN SIZE.